

amputations-und resektiossagen | sierra para amputacion y reseccion
 Scies a amputation et resection | seghe per amputazione



Satterlee Saw
 10-001 29cm
 Stainless Steel Ring Handle
 Straight tip, Straight shaft



Charriere Bone Saw
 10-002 27cm
 10-003 30cm
 10-004 34cm
 Straight tip, Straight shaft



Charriere Saw
 10-005 35cm
 Spare saw blades
 10-006 12mm
 10-007 15mm



Charriere Bone Saw Complete
 10-008 35.5cm
 Straight tip,
 Straight shaft



Helferich-Bier Saw
 10-009 39cm
 Spare saw blades
 10-010 3mm
 10-011 5mm
 10-012 5mm



Charriere Saw
 10-013 25 cm
 10-014 27 cm
 Double saw



Engel Plaster Saw
 10-015 15.5 cm



Serra Gigli
 10-016 30 cm
 10-017 40 cm
 10-018 50 cm



Percy Amputation Shield
 10-019 30.5cm
 Handles Detachable,
 Simple Pattern



Putti Bone Rasp
 10-020 27cm
 Double ended,
 One end curved up
 one end curved sideways



Putti Rasp
 10-021 30cm
 Double Ended



Putti Bone File
 10-022 28cm
 semicircular



Putti Bone File
 Bayonet Shape
 10-023 24.5cm
 X=13 mm
 semicircular



Putti Bone File
 10-024 22cm
 X=20 mm
 flat



Joseph Bone Saw / Rasp
 10-025 19cm
 Single Sided



Linderman Amputation Saw
 10-026 19cm
 20cm Blade



Wellenschliff Nasal Saw
 10-027 19cm
 Straight



Langenbeck Metacarpal Saw
 10-028 23cm
 11.5cm Blade

Knochenfeilen

Limes à os

Limas para huesos

Lime per ossa



Patella Bone Saw
10-029 Includes 1 blade
10-030 Replacement blade only
 Delrin Handle



Foman Rasp
10-031 21.5cm
 Double ended, Fine & coarse serrations 4-sided convex and flat blades



Foman Rasp
10-032 21cm

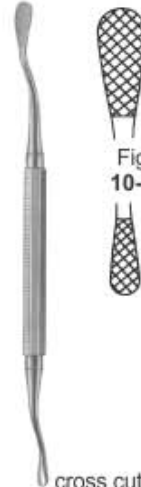

Miller-Colburn Bone File
 18 cm



Fig. 1
10-033



Fig. 2
10-034

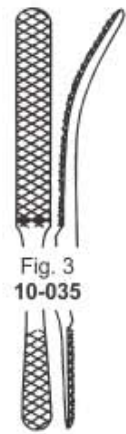

Fig. 3
10-035

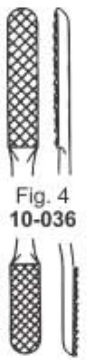

Fig. 4
10-036

cross cut



Kleinert-Kutz Bone Rasp
10-037 22.5cm
 Double ended,
 Fine & coarse serrations



Miller Alveotomy File
10-038 19cm



Miller Alveotomy File
10-039 19cm



Gallaher Bone Rasp
10-040 18cm
10-041 25cm
 Curved



Gallaher Bone Rasp
10-042 18cm
10-043 25cm
 Convex Curve



Gallaher Bone Rasp
10-044 18cm
10-045 25cm
 Straight



Good Bone File / Rasp
10-046 16.5cm
 Straight



Kistler Ear Cartilage Rasp
10-047 left
10-048 right
 16.5cm Curved



Micro Rasp
10-049 14cm
 Single ended
 double sided



Nail Rasp
10-050 17cm
 Single sided



Maltz Rasp
10-051 18cm
 Single-Ended
 Single sided



Improved Maltz Rasp
10-052 18cm
 Single-Ended,
 up & down rasping



Putti Rasp
10-053 23cm
 falt / flat
10-054 30.5cm
 Round / flat

Raspeln, Feilen
Rapes, Limes

Escofinas, limas
Raspe, lime



Miller Rasp
10-055 21.5cm
Double Ended straight
single Sided



Fomon Rasp
10-056 21.5cm
Double Ended straight
single Sided
one side concave



Fomon Rasp
10-057 21.5cm
Double Ended straight
single Sided
one side convex



Fomon Rasp
10-058 21.5cm
Double Ended straight
single Sided



Fomon Rasp
10-059 21.5cm
Double Ended straight
single Sided
one side concave



Fomon Rasp
10-060 21.5cm
Double Ended straight
single Sided
one side convex



Chisel Blade Handle
10-061 18.5cm



10-062 8.5cm
5mm
10-063 8.5cm
10mm
10-064 8.5cm
16mm
10-065 8.5cm
25mm



10-066 8.5cm
5mm
10-067 8.5cm
10mm
10-068 8.5cm
16mm
10-069 8.5cm
25mm



Chisel Blade key
10-070 9cm



Osteotome
13.5cm
10-071 8mm
10-072 10mm
10-073 12mm
10-074 14mm
10-075 16mm



Chisel
13.5cm
10-076 8mm
10-077 10mm
10-078 12mm
10-079 14mm
10-080 16mm



Gouge
13.5cm
10-081 8mm
10-082 10mm
10-083 12mm
10-084 14mm
10-085 16mm



Lucas Chisel
16cm
10-086 3mm
10-087 4mm
10-088 5mm
10-089 6mm



Lucas Gouge
16cm
10-090 3mm
10-091 4mm
10-092 5mm
10-093 6mm



U.S. Army Pattern Chisel
16.5 cm
10-094 6 mm wide
10-095 12 mm wide
10-096 18 mm wide



| Partsch Chisel | Partsch Chisel | Partsch Chisel |
|-------------------|-------------------|-------------------|
| 11.5cm | 13.5cm | 17.5cm |
| 10-097 2mm | 10-103 2mm | 10-109 2mm |
| 10-098 3mm | 10-104 3mm | 10-110 3mm |
| 10-099 4mm | 10-105 4mm | 10-111 4mm |
| 10-100 6mm | 10-106 6mm | 10-112 6mm |
| 10-101 7mm | 10-107 7mm | 10-113 7mm |
| 10-102 8mm | 10-108 8mm | 10-114 8mm |

Knochenmeißel

Cineles, gubias

Ciseaux-burins, gouges

Scalpelli, sgorbi



| Partsch Gouge | Partsch Gouge | Partsch Gouge |
|---------------|---------------|---------------|
| 11.5cm | 13.5cm | 17.5cm |
| 10-115 2mm | 10-121 2mm | 10-127 2mm |
| 10-116 3mm | 10-122 3mm | 10-128 3mm |
| 10-117 4mm | 10-123 4mm | 10-129 4mm |
| 10-118 6mm | 10-124 6mm | 10-130 6mm |
| 10-119 7mm | 10-125 7mm | 10-131 7mm |
| 10-120 8mm | 10-126 8mm | 10-132 8mm |



Alexander Chisel
18cm

| |
|-------------|
| 10-133 4mm |
| 10-134 6mm |
| 10-135 8mm |
| 10-136 10mm |
| 10-137 12mm |
| 10-138 14mm |



Alexander Gouge
18cm

| |
|-------------|
| 10-139 4mm |
| 10-140 6mm |
| 10-141 8mm |
| 10-142 10mm |
| 10-143 12mm |
| 10-144 14mm |



Smith Peterson Gouge
20cm Straight

| |
|--------------|
| 10-145 09 mm |
| 10-146 14 mm |
| 10-147 19 mm |
| 10-148 25 mm |

Curved

| |
|--------------|
| 10-149 09 mm |
| 10-150 14 mm |
| 10-151 19 mm |
| 10-152 25 mm |



Straight

| |
|--------------|
| 10-153 06 mm |
| 10-154 09 mm |
| 10-155 13 mm |
| 10-156 16 mm |
| 10-157 19 mm |
| 10-158 25 mm |
| 10-159 32 mm |

Curved

| |
|--------------|
| 10-160 06 mm |
| 10-161 09 mm |
| 10-162 13 mm |
| 10-163 16 mm |
| 10-164 19 mm |
| 10-165 25 mm |
| 10-166 32 mm |

Smith Peterson Osteotome
20 cm



Straight

| |
|--------------|
| 10-167 10 mm |
| 10-168 15 mm |
| 10-169 20 mm |
| 10-170 25 mm |

Curved

| |
|--------------|
| 10-171 10 mm |
| 10-172 15 mm |
| 10-173 20 mm |
| 10-174 25 mm |

Stille Gouge
20 cm



Chisels

| |
|--------------|
| 10-175 10 mm |
| 10-176 12 mm |
| 10-177 15 mm |
| 10-178 20 mm |
| 10-179 25 mm |

Osteotome

| |
|--------------|
| 10-180 10 mm |
| 10-181 12 mm |
| 10-182 15 mm |
| 10-183 20 mm |
| 10-184 25 mm |

Stille
20 cm



Stille Chisel
20 cm



10 mm
10-185



15 mm
10-186



20 mm
10-187

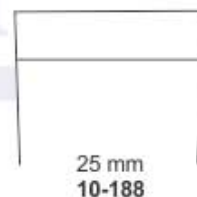

25 mm
10-188



10 mm
10-189



15 mm
10-190



20 mm
10-191

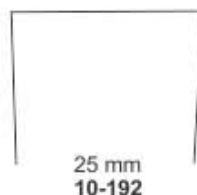

25 mm
10-192

Stille Osteotome
20 cm



Lexer Osteotome
22 cm

| |
|--------------|
| 10-193 7 mm |
| 10-194 10 mm |
| 10-195 12 mm |
| 10-196 15 mm |
| 10-197 20 mm |
| 10-198 25 mm |
| 10-199 30 mm |

Lexer Modif. Osteotome
29 cm

| |
|--------------|
| 10-200 7 mm |
| 10-201 10 mm |
| 10-202 12 mm |
| 10-203 15 mm |
| 10-204 20 mm |
| 10-205 25 mm |
| 10-206 30 mm |



Lexer Modif. Chisel
29 cm

| |
|--------------|
| 10-207 7 mm |
| 10-208 10 mm |
| 10-209 12 mm |
| 10-210 15 mm |
| 10-211 20 mm |
| 10-212 25 mm |
| 10-213 30 mm |

Lexer Chisel
22 cm

| |
|--------------|
| 10-214 7 mm |
| 10-215 10 mm |
| 10-216 12 mm |
| 10-217 15 mm |
| 10-218 20 mm |
| 10-219 25 mm |
| 10-220 30 mm |



Lexer Gouge
25 cm

| |
|--------------|
| 10-221 7 mm |
| 10-222 10 mm |
| 10-223 15 mm |

Straight

Knochenmeißel

Cineles, gubias

Ciseaux-burins, gouges

Scalpelli, sgorbi



Lexer Gouge
25 cm
10-224 7 mm
10-225 10 mm
10-226 15 mm
Curved



Lexer Osteotome Flat
22 cm
10-227 10 mm
10-228 15 mm
10-229 20 mm
10-230 25 mm



Lexer Gouge Tuffnel Handle
22 cm
10-231 10 mm
10-232 15 mm
10-233 20 mm
10-234 25 mm



Mini Lexer Osteotome
10-235
18 cm



Mini Lexer Chisel
10-236
18 cm



Capener Osteotome With Tuffnel Handle
25cm
10-237 10mm
10-238 12mm
10-239 15mm
10-240 20mm
10-241 25mm
10-242 30mm
Straight



Capener Osteotome With Tuffnel Handle
25cm
10-243 10mm
10-244 12mm
10-245 15mm
10-246 20mm
10-247 25mm
10-248 30mm
Curved



Capener Chisels With Tuffnel Handle
25cm
10-249 6mm
10-250 8mm
10-251 10mm
10-252 12mm
10-253 15mm
10-254 20mm
10-255 25mm
10-256 30mm
Straight



Capener Osteotome With Tuffnel Handle
25cm
10-257 6mm
10-258 8mm
10-259 10mm
10-260 12mm
10-261 15mm
10-262 20mm
10-263 25mm
10-264 30mm
Curved



Raspatories
10-265 20cm
Medium straight blade
round edge, width 14mm



Raspatories
10-266 20cm
Large straight blade
round edge, width 20mm



Raspatories
10-267 20cm
Medium curved blade
round edge, width 14mm



Raspatories
10-268 20cm
Large curved blade
round edge, width 20mm



Mini Lexer Osteotome
10-269 20cm
18mm



Raspatories
10-270
28cm



Raspatories
10-271
28cm



Chisel
10-272
115mm/280mm
for extraction of cement

Knochenmeißel

Cineles, gubias

Ciseaux-burins, gouges

ScalPELLi, sgorbi



Chisel
10-273
for extraction
of cement 9mm
Positive 400mm



Chisel
10-274
with 2 prong



**Lambotte
Osteotome**
25cm
10-275 6mm
10-276 8mm
10-277 10mm
10-278 13mm
10-279 15mm
10-280 20mm
10-281 25mm
10-282 30mm
10-283 38mm
10-284 44mm
10-285 50mm
Straight



**Lambotte
Osteotome**
25cm
10-286 6mm
10-287 8mm
10-288 10mm
10-289 13mm
10-290 15mm
10-291 20mm
10-292 25mm
10-293 30mm
10-294 38mm
10-295 44mm
10-296 50mm
Curved



**Mini-Lambotte
Osteotome**
12.5cm
10-297 3mm
10-298 4mm
10-299 6mm
10-300 8mm
10-301 10mm
10-302 12mm
10-303 15mm
Straight



**Mini-Lambotte
Osteotome**
17cm
10-304 3mm
10-305 4mm
10-306 6mm
10-307 8mm
10-308 10mm
10-309 12mm
10-310 15mm
Straight



Lambotte Osteotome
12.5cm, Straight
10-311 2mm tip width
10-312 4mm tip width
10-313 6mm tip width
10-314 8mm tip width
10-315 10mm tip width
10-316 12mm tip width
10-317 15mm tip width



Hex Handle Osteotome
15cm, Straight
10-318 2mm tip width
10-319 3mm tip width
10-320 4mm tip width
10-321 5mm tip width
10-322 6mm tip width
10-323 7mm tip width
10-324 9mm tip width
10-325 10mm tip width



Cottle Osteotome
18.5cm, Straight
10-326 4mm tip width
10-327 6mm tip width
10-328 9mm tip width
10-329 12mm tip width



**Anderson-Nievert
Osteotome**
20.4cm
10-330 Curved right
10-331 Curved left
10-332 Straight



Freer Gouge
10-333 15cm
06mm



Freer Chisel
10-334 16cm
04mm



**Shoulder
Penetrating Gouge**
10-335 21.6cm
Straight, 3mm distal tip



**Ballenger
Chisel** 16cm
10-336
4mm
10-337
6mm
10-338
8mm



**Mannerfelt
Modif.**



Osteotomes
10-339 4mm
10-340 6mm
10-341 8mm
15.5cm



Gouge
10-342
4mm
15.5cm



**Kilian,
Septum Gouge**
10-343 16cm
5mm



**Kilian-Claus
Septum Gouge**
10-344 16cm
5mm

Knochenmeißel

Cineles, gubias

Ciseaux-burins, gouges

Scalpelli, sgorbi



Stille
20cm



Stille Chisel
10-345 10mm
10-346 15mm
10-347 20mm
10-348 25mm
Straight



Stille Osteotome
10-349 10mm
10-350 15mm
10-351 20mm
10-352 25mm
Straight



Stille Osteotome
10-353 10mm
10-354 15mm
10-355 20mm
10-356 25mm
Curved



Stille Gouge
10-357 10mm
10-358 15mm
10-359 20mm
10-360 25mm
Straight



Stille Gouge
10-361 10mm
10-362 15mm
10-363 20mm
10-364 25mm
Curved



Smith-Petersen
20cm 8"



Smith-Petersen osteotome
10-365 6mm
10-366 9mm
10-367 13mm
10-368 16mm
10-369 19mm
10-370 25mm
10-371 32mm
Straight



Smith-Petersen Osteotome
10-372 6mm
10-373 9mm
10-374 13mm
10-375 16mm
10-376 19mm
10-377 25mm
10-378 32mm
Curved



Smith-Petersen Gouge
10-379 9mm
10-380 16mm
10-381 19mm
10-382 25mm
Straight



Smith-Petersen Gouge
10-383 9mm
10-384 16mm
10-385 19mm
10-386 25mm
Curved



Hoke Osteotome
14cm
10-387 3mm
10-388 5mm
10-389 7mm
10-390 8.5mm
10-391 10mm
10-392 12mm



Hibbs
24cm



Hibbs Osteotome
10-393 6mm
10-394 13mm
10-395 19mm
10-396 25mm
10-397 32mm
Straight



Hibbs Chisel
10-398 6mm
10-399 13mm
10-400 19mm
10-401 25mm
10-402 32mm
Straight



Hibbs Osteotome
10-403 6mm
10-404 13mm
10-405 19mm
10-406 25mm
10-407 32mm
Curved



Hibbs Gouge
10-408 6mm
10-409 13mm
10-410 19mm
10-411 25mm
10-412 32mm
Straight



Hibbs Gouge
10-413 6mm
10-414 13mm
10-415 19mm
10-416 25mm
10-417 32mm
Curved

Knochenmeißel

Cineles, gubias

Ciseaux-burins, gouges

Scalpelli, sgorbi

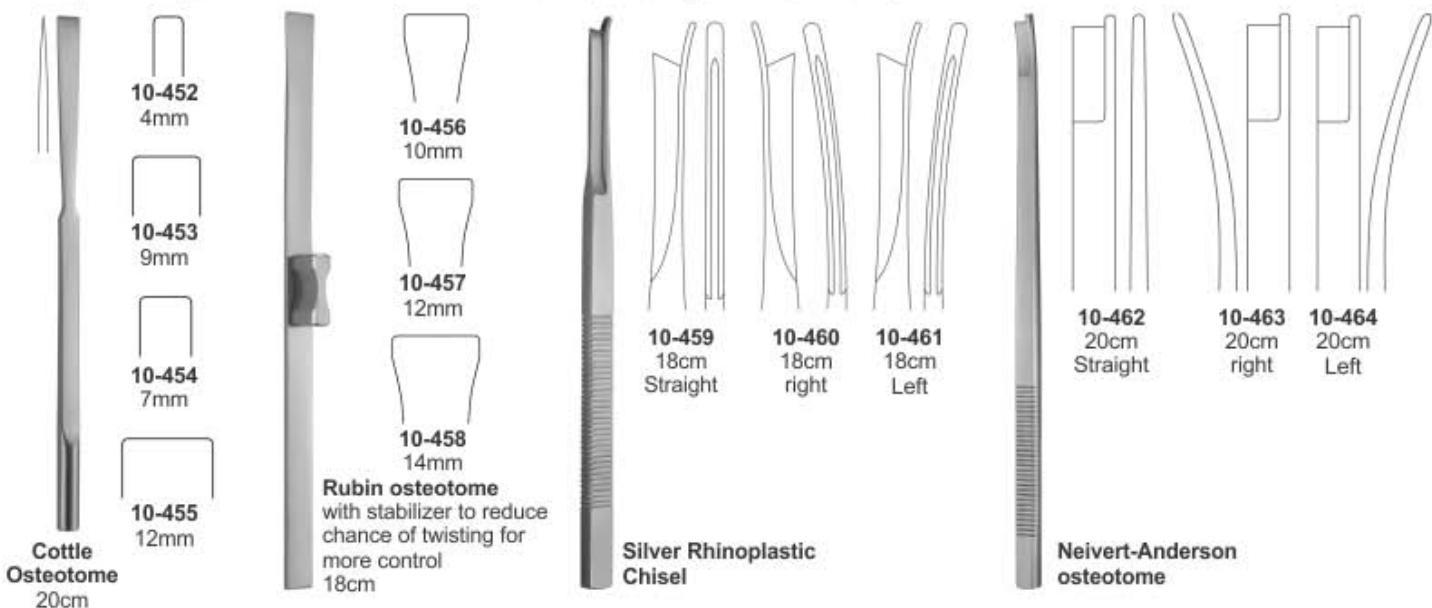
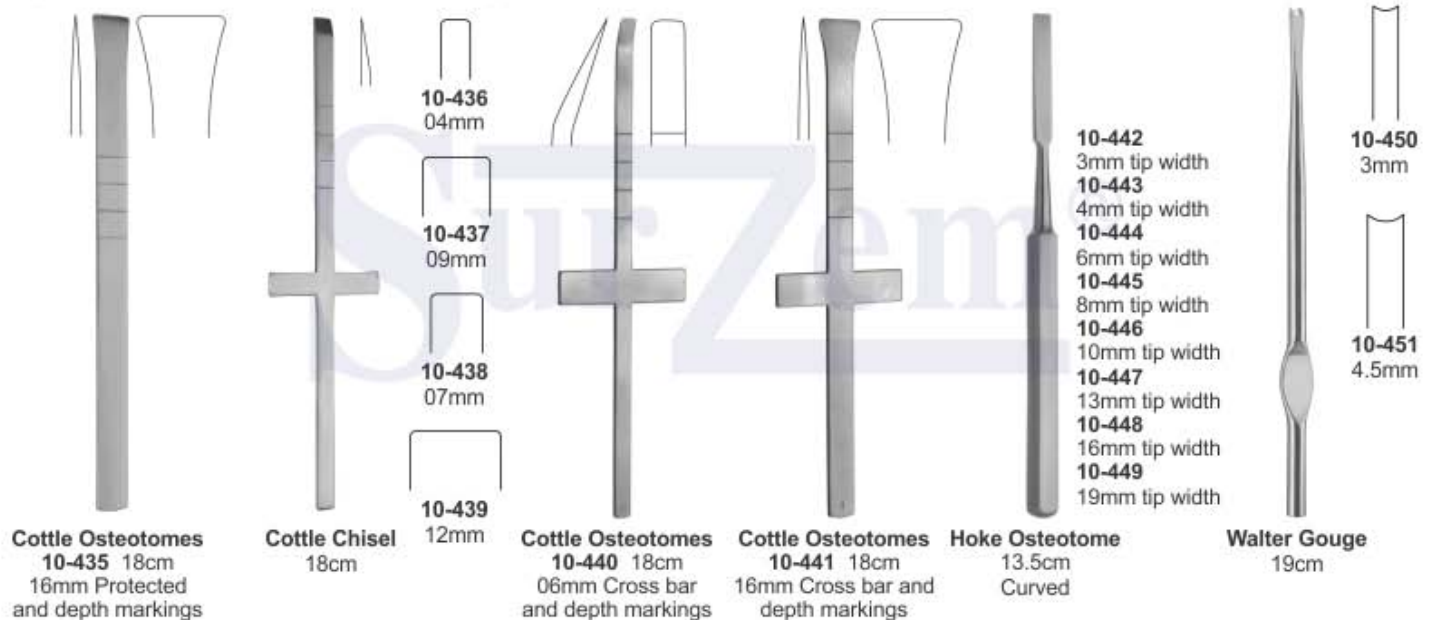
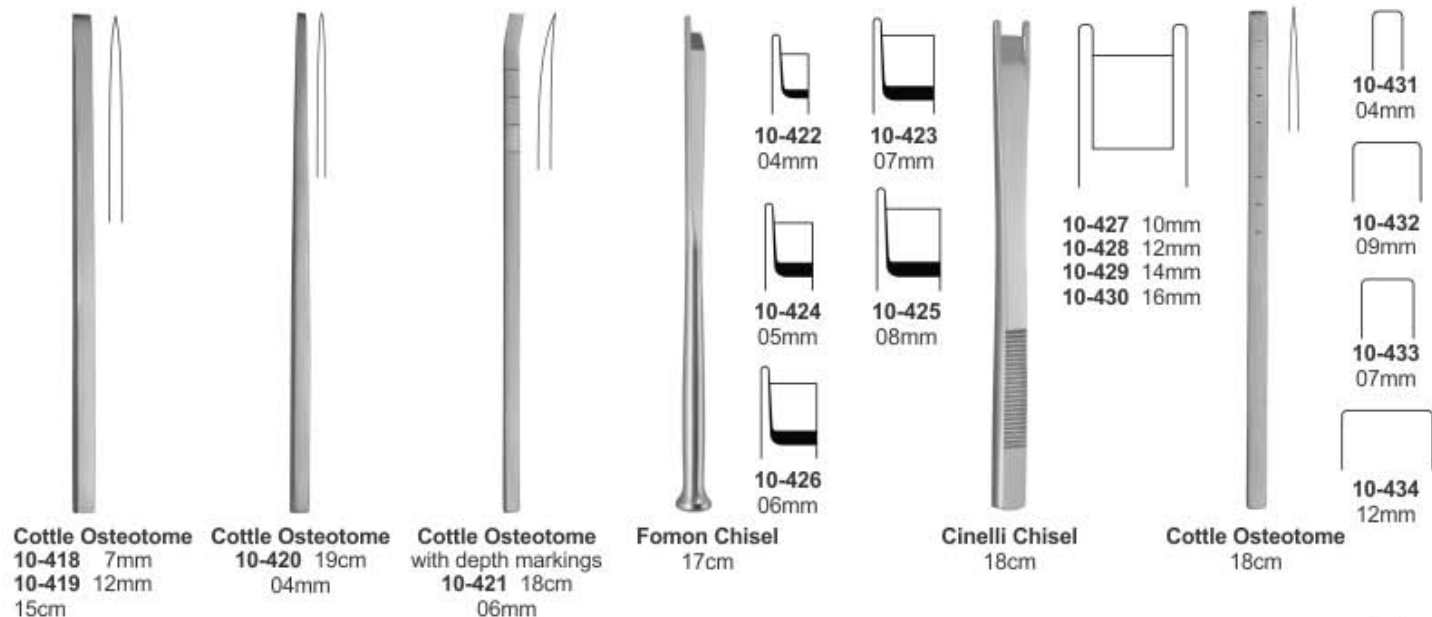

Meißel zur Nasenplastik

Cinceles para rinoplastica

Osteotomes, ciseaux-burins pour rhinoplastique

Scalpelli per plastica nasale

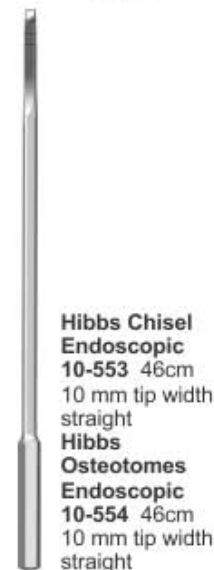
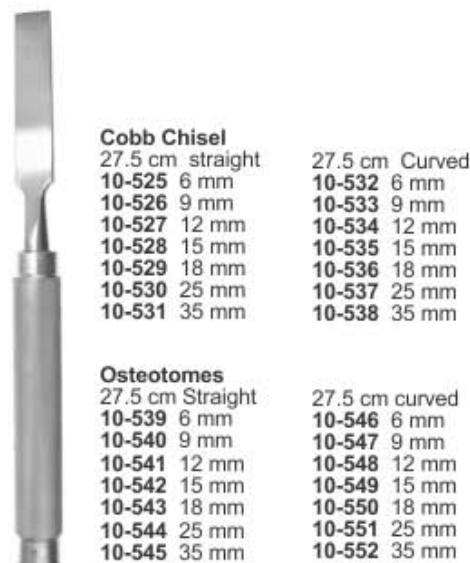
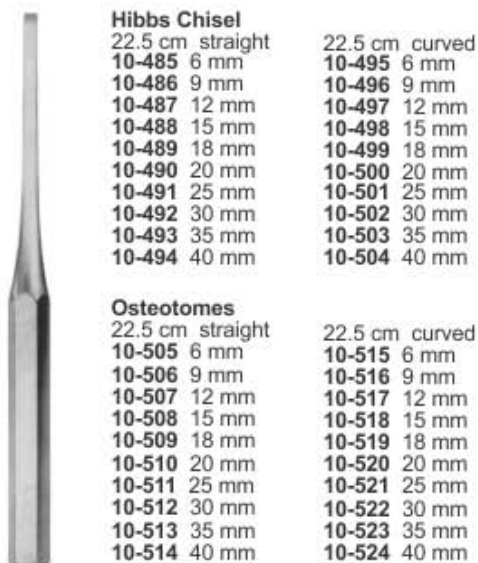
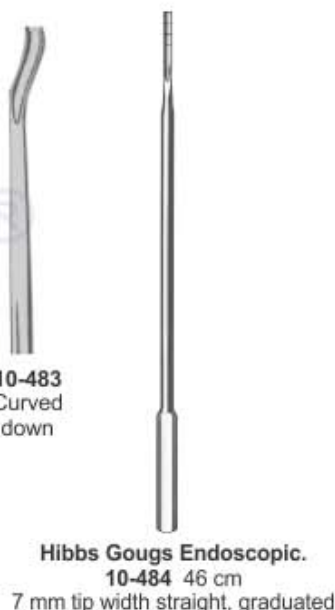
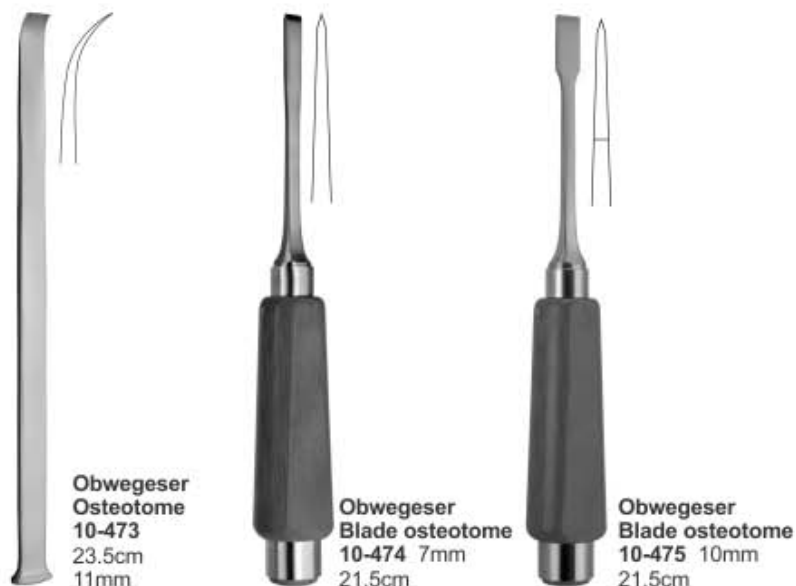
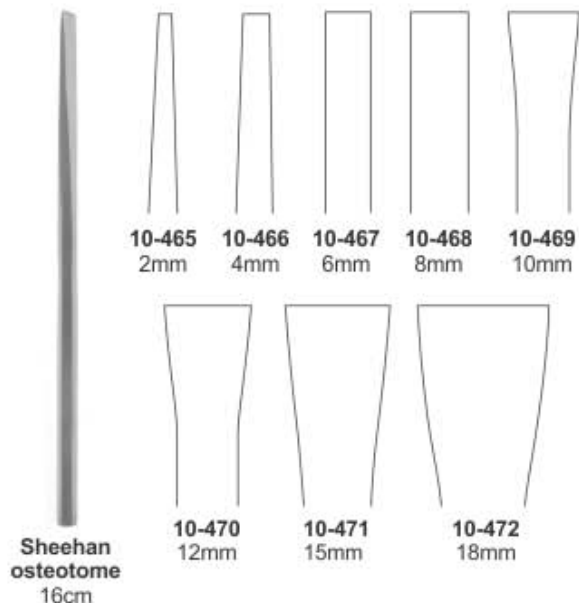

Hibbs Chisel / Osteotomes

Cobb Chisel / Osteotomes

MALLETS

Hammer | Martillos
Maillets | Martelli



Doyen Mallets
25cm
10-555
25mmØ - 120g
10-556
30mmØ - 180g
10-557
35mmØ - 260g



Collin Mallets
10-558
20cm
30mmØ - 220g



Hajek Mallets
10-559
21.5cm
27mmØ - 140g



Kirk Mallets
10-560 19cm
38mmØ - 750g
10-561 20.4cm
Head diameter
38.0mm,
Weight: 1 lb. 4 oz.
570 grams



Partsch Mallets
10-562 18cm
22mmØ - 200g



Lucae Mallets
10-563
19mmØ - 220g
10-564
25mmØ - 260g
19cm



Mallet Mallets
10-565 19cm
250mmØ - 205g
Solid steel, with
plastic faces



Cottle Mallets
10-566
18.5cm
30mmØ - 240g
1 side flat /
1 side convex



Williger Hammer
10-567 250g
10-568 350g



Neufield Hammer
10-569



**Solid Copper
Head Mallet**
10-570 16.5cm
Solid, Head
diameter
20mm



Nylon Head Mallet
10-571 19cm
Head diameter 25.4mm,
7.76 oz.
10-572 19.5cm
Head diameter 3cm
Weight 11 oz.



**Extra 3cm Nylon Face
FOR 10-572**
10-573 Head diameter
3cm



Combination Mallet
10-574 19.5cm
Solid, Head
diameter 32.0mm,
Weight 12 oz 340
grams, Head weight:
8 oz 227 grams



**Bergmann
Mallets**
10-575
24.5cm
45mmØ - 300g

| | |
|----------|-----------|
| Hammer | Martillos |
| Maillets | Martelli |



Ombredanne Mallets
10-576 24cm
 40mmØ - 550g



Heath Mallets
10-577 18cm
 40mmØ - 700g
10-578 20cm
 45mmØ - 1000g



Williger Mallets
10-579
 28mmØ - 340g
10-580
 30mmØ - 400g
 24cm
 Lead filled



Hajek Hammer
10-581 250gm
10-582 500gm



Universal Hammer
10-583 500gm
10-584 750gm



Mallet, Lightweight
10-585 19cm
 Stainless Steel and Aluminum
 Head diameter 25.0mm
 Weight 7 oz 200 grams
 Head Weight: 4 oz 113 grams



Nylon Caps Left & Right FOR 10-585 (PAIR)
10-586
 2.5cm



Mallet #49
10-587 19.5cm
 Head diameter 22.0mm
 Weight 7 oz 200 grams
 Head Weight: 5oz/150 grams



Mead Mallet
10-588 19cm
 Head diameter 26.0mm
 Weight 11 oz 315 grams
 Head Weight: 6 oz 170 grams



Heath Mallet, Heavyweight
10-589 19cm
 Head diameter 40.0mm
 Weight 2 lbs. (907 grams)
 Head Weight: 20 oz (567 grams)



Orthopedic Mallet
10-590 27.5cm
 Lightweight
 Solid, Head diameter 35.0mm
 Weight 2 lbs. (907 grams)
 Head Weight: 1 lb. (454 grams)



Orthopedic Mallet
10-591 28cm
 Heavyweight
 Solid, Head diameter 50.0mm
 Head Weight: 2 lb. (900 grams)



Ortho Mallets
10-592
 26.5cm (450g)



Phenolic Handle Mallet
10-593 28 cm
 Head diameter 32mm
 Head weight 16 oz (454 grams)
10-594 Head diameter 45mm
 Weight 11 oz (312 grams);
 Head weight: 2 lbs (907 grams),



Nylon Cap
10-593
 For Phenolic Handle Mallet

| | |
|-----------------|------------------|
| <i>Hammer</i> | <i>Martillos</i> |
| <i>Maillets</i> | <i>Martelli</i> |



Reprocussion Free Mallet Cap For 10-596

Reprocussion Free Mallet 10-595 28cm
Head diameter 30mm
Weight 1lb 5 oz (595 grams)
Head weight: 10 oz (283 grams)



Mallet 10-597 26cm
Plane (Nylon) convex (steel)
Head 30mm Ø
weight 675 grams.



Mallet 10-598 26cm
Head 42/30mm Ø
weight 530 grams



Mallet 10-599 26cm
Plastic Handle head 30mm Ø
weight 510 grams



Vickers Mallets 10-600 19 cm
25mmØ - 300g
nylon disks plastic



Herbert Mallets 10-601 19 cm
25mmØ - 300g
for ulnar head prosthesis plastic handle



Mallet 10-602 18cm
Made of Plastic
Head 30mm Ø
weight 125 grams



Mallet 10-603 26 cm
Made of Plastic with lead filling
Head 42mm Ø
weight 250 grams



Mallet 10-604 22.5 cm
Disks & Plastic Handle
Head 37mm Ø
weight 370 grams



Mallet 10-606 26 cm
Made of Plastic with lead filling
Head 42 mm Ø
weight 400 grams



Mallet 10-608 24cm
Plastic Handle
Head 30mm Ø
weight 480 grams



Mallet 10-609



Mallet 10-610



Mallet 10-611



Mallet 10-612

Raspatorien, Stobel
Periostótomos, Pílons

Rugines-raspatoires, Punzones
Periostotomi, Pestoni

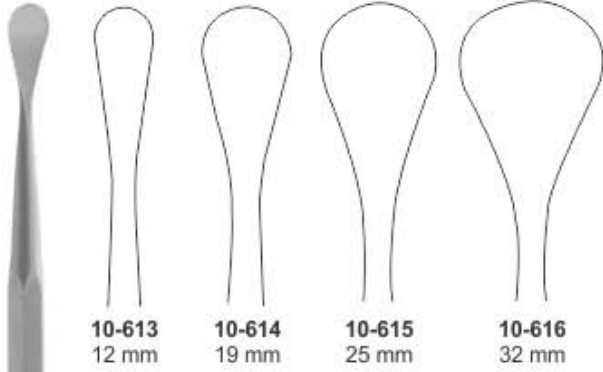

10-613 12 mm
10-614 19 mm
10-615 25 mm
10-616 32 mm

Cobb Spinal Elevator
23.8 cm sharp
with hexagonal handle

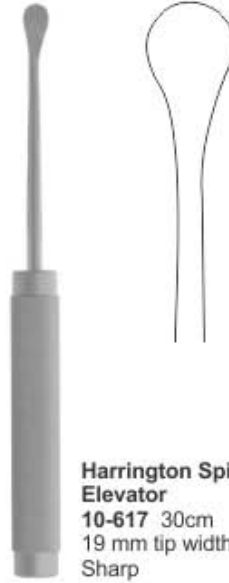

Harrington Spinal Elevator
10-617 30cm
19 mm tip width
Sharp

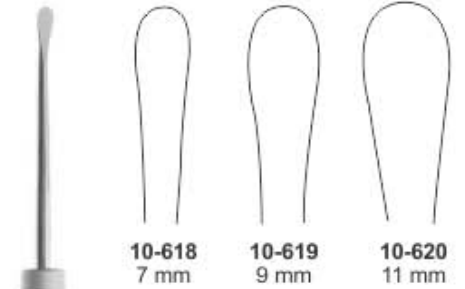

10-618 7 mm
10-619 9 mm
10-620 11 mm

Cobb Modif.
28 cm
Round Handle

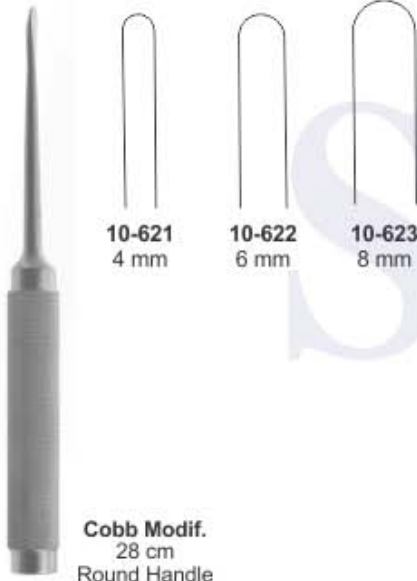

Cobb Modif.
28 cm
Round Handle

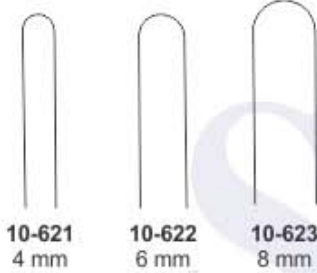

10-621 4 mm
10-622 6 mm
10-623 8 mm



Sebileau Periosteal Elevator

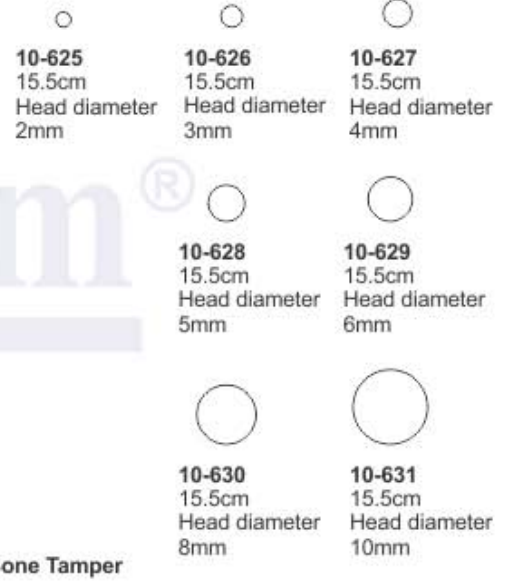

10-625 15.5cm
Head diameter 2mm
10-626 15.5cm
Head diameter 3mm
10-627 15.5cm
Head diameter 4mm
10-628 15.5cm
Head diameter 5mm
10-629 15.5cm
Head diameter 6mm
10-630 15.5cm
Head diameter 8mm
10-631 15.5cm
Head diameter 10mm

Bone Tamper



10-632 2.5mm x 2.5mm
10-633 3.5mm x 3.5mm
Passow Bone Tamper
12cm



10-634 3mm
10-635 5mm
10-636 8mm
Caspar Bone Tamper
20cm



10-637 12mm
10-638 14mm
10-639 16mm
Caspar Bone Tamper
20cm



Tip Size
2 mm
3 mm
4 mm
5 mm
6 mm
8 mm
10 mm
Bone Tamps
10-640
15.4 cm

Scharfe Löffel
Curettes tranchantes

cucharillas cortantes
Cucchiai taglianti



Volkman Bone Curette

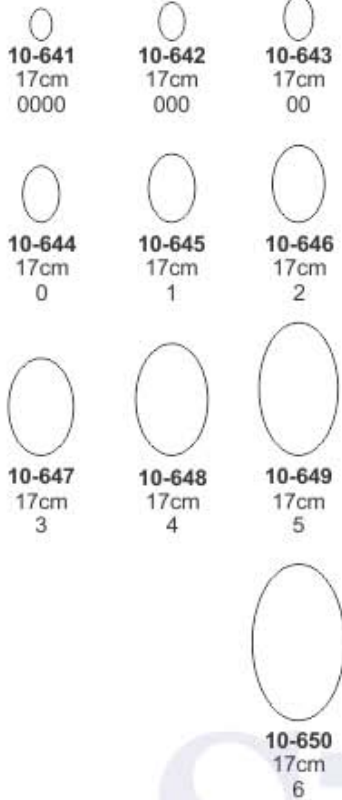

10-641
17cm
0000

10-642
17cm
000

10-643
17cm
00

10-644
17cm
0

10-645
17cm
1

10-646
17cm
2

10-647
17cm
3

10-648
17cm
4

10-649
17cm
5

10-650
17cm
6



Schede Bone Curette
17cm

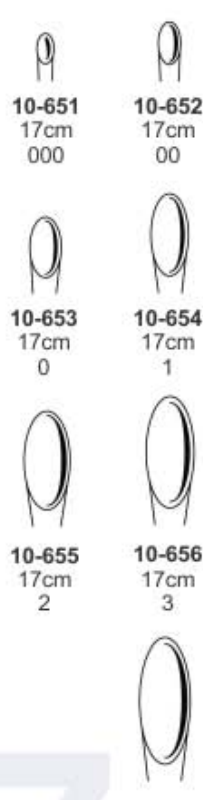

10-651
17cm
000

10-652
17cm
00

10-653
17cm
0

10-654
17cm
1

10-655
17cm
2

10-656
17cm
3

10-657
17cm
4



Bruns Bone Curette

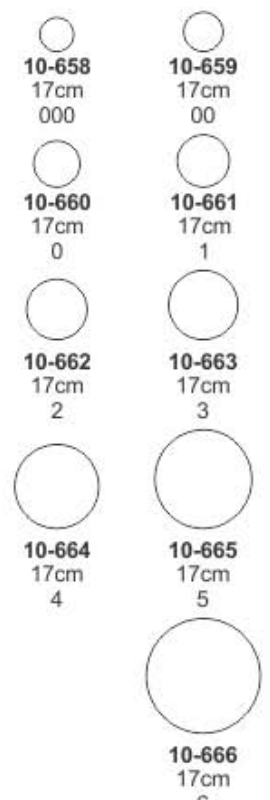

10-658
17cm
000

10-659
17cm
00

10-660
17cm
0

10-661
17cm
1

10-662
17cm
2

10-663
17cm
3

10-664
17cm
4

10-665
17cm
5

10-666
17cm
6



Spratt Bone Curette / Hollow Handle

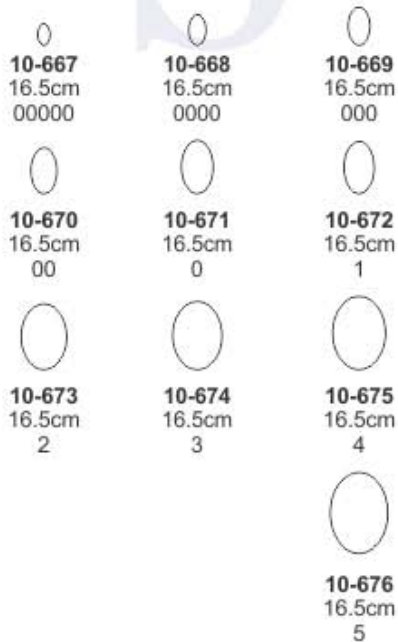

10-667
16.5cm
00000

10-668
16.5cm
0000

10-669
16.5cm
000

10-670
16.5cm
00

10-671
16.5cm
0

10-672
16.5cm
1

10-673
16.5cm
2

10-674
16.5cm
3

10-675
16.5cm
4

10-676
16.5cm
5



Halle Bone Curette Flexible



10-677
21cm
1

10-678
21cm
2

10-679
21cm
3



Uffnorde Bone Curette Left
10-680 17.5cm



Uffnorde Bone Curette Right
10-681 17.5cm

BONE CURETTES

Scharfe Löffel
Curettes tranchantes

cucharillas cortantes
Cucchiai taglienti



Bruns Bone Curette
23 cm

- Fig.1
10-682
- Fig.2
10-683
- Fig.3
10-684
- Fig.4
10-685
- Fig.5
10-686
- Fig.6
10-687
- Fig.7
10-688
- Fig.8
10-689
- Fig.9
10-690



Bone Curette
Straight

- 10-691
20cm
000
- 10-692
20cm
00
- 10-693
20cm
0
- 10-694
20cm
1
- 10-695
20cm
2
- 10-696
20cm
3
- 10-697
20cm
4
- 10-698
20cm
5
- 10-699
20cm
6



Bone Curette
Curved

- 10-700
20cm
000
- 10-701
20cm
00
- 10-702
20cm
0
- 10-703
20cm
1
- 10-704
20cm
2
- 10-705
20cm
3
- 10-706
20cm
4
- 10-707
20cm
5
- 10-708
20cm
6



Schroeder Bone Curette
Sharp / rigid

- 10-709
30cm
1
- 10-710
30cm
2
- 10-711
30cm
3
- 10-712
30cm
4
- 10-713
30cm
5
- 10-714
30cm
6



Simon Bone Curette
Sharp / rigid

- 10-715
24cm
0000
- 10-716
24cm
000
- 10-717
24cm
00
- 10-718
24cm
0
- 10-719
25cm
1
- 10-720
25cm
2
- 10-721
25cm
3
- 10-722
25cm
4
- 10-723
25cm
5
- 10-724
25cm
6

BONE CURETTES

Scharfe Löffel | cucharillas cortantes
Curettes tranchantes | Cucchiai taglianti

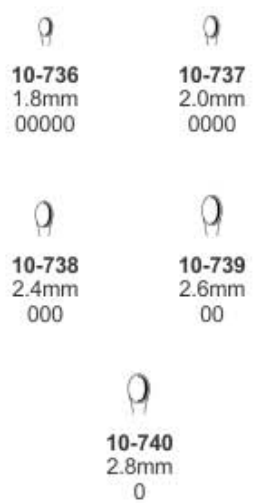
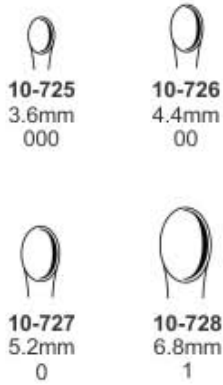

Bone Curette
25 cm
Straight

Daubenspeck Bone Curette
20 cm

Scoville Bone Curette
25 cm

Lempert Bone Curette
21.5 cm

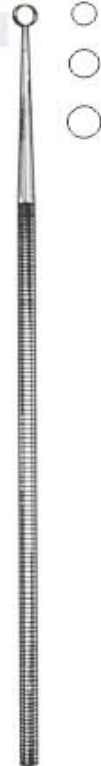
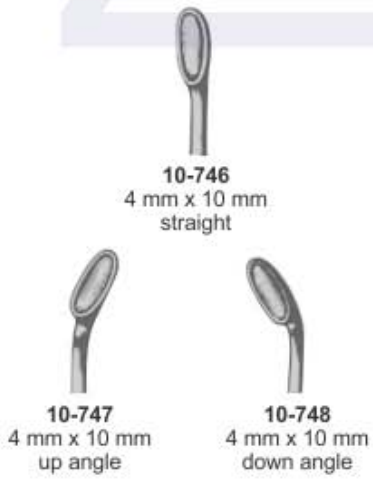
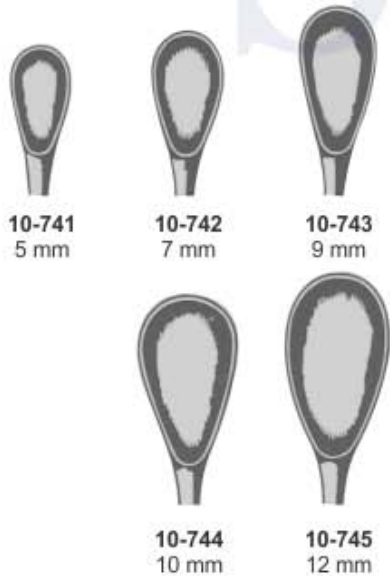

Cushing Bone Curette
23.5 cm
Pituitary Spoon,
malleable, silver-plated

Scoville Bone Curette
25 cm
Ruptured Disc Curette

Tay-Bronson Bone Curette
22 cm
Pituitary Curette, double-edged

Scharfe Löffel
Curettes tranchantes

cucharillas cortantes
Cucchiai taglianti

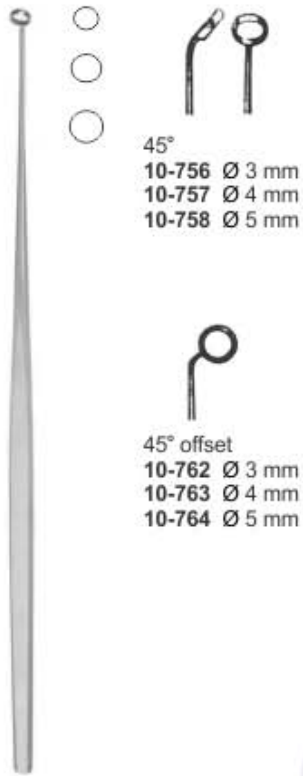

Ray Bone Curette, 19 cm
Pituitary Curette

45°
10-756 Ø 3 mm
10-757 Ø 4 mm
10-758 Ø 5 mm

90°
10-759 Ø 3 mm
10-760 Ø 4 mm
10-761 Ø 5 mm

45° offset
10-762 Ø 3 mm
10-763 Ø 4 mm
10-764 Ø 5 mm

90° offset
10-765 Ø 3 mm
10-766 Ø 4 mm
10-767 Ø 5 mm

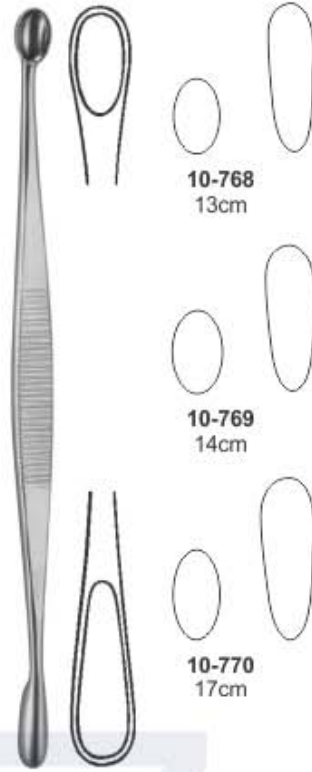

Volkmann Curette
Oval / Oval

10-768
13cm

10-769
14cm

10-770
17cm

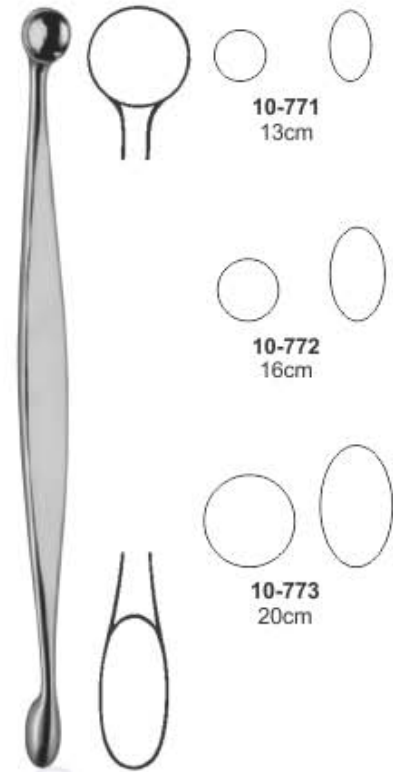

Volkmann Curette
Round / Oval

10-771
13cm

10-772
16cm

10-773
20cm



Curette
10-774
21cm
round / oval



Martini Curette
13.5cm

- 10-775 00
- 10-776 0
- 10-777 0
- 10-778 1
- 10-779 1
- 10-780 2



Martini Curette
15.5cm

- 10-781 00
- 10-782 0
- 10-783 1



Williger Curette
13.5cm

- 10-784 00
- 10-785 0
- 10-786 0
- 10-787 1
- 10-788 1
- 10-789 2



Williger Curette
15.5cm

- 10-790 00
- 10-791 0
- 10-792 1

Scharfe Löffel | cucharillas cortantes
Curettes tranchantes | Cucchiai taglianti

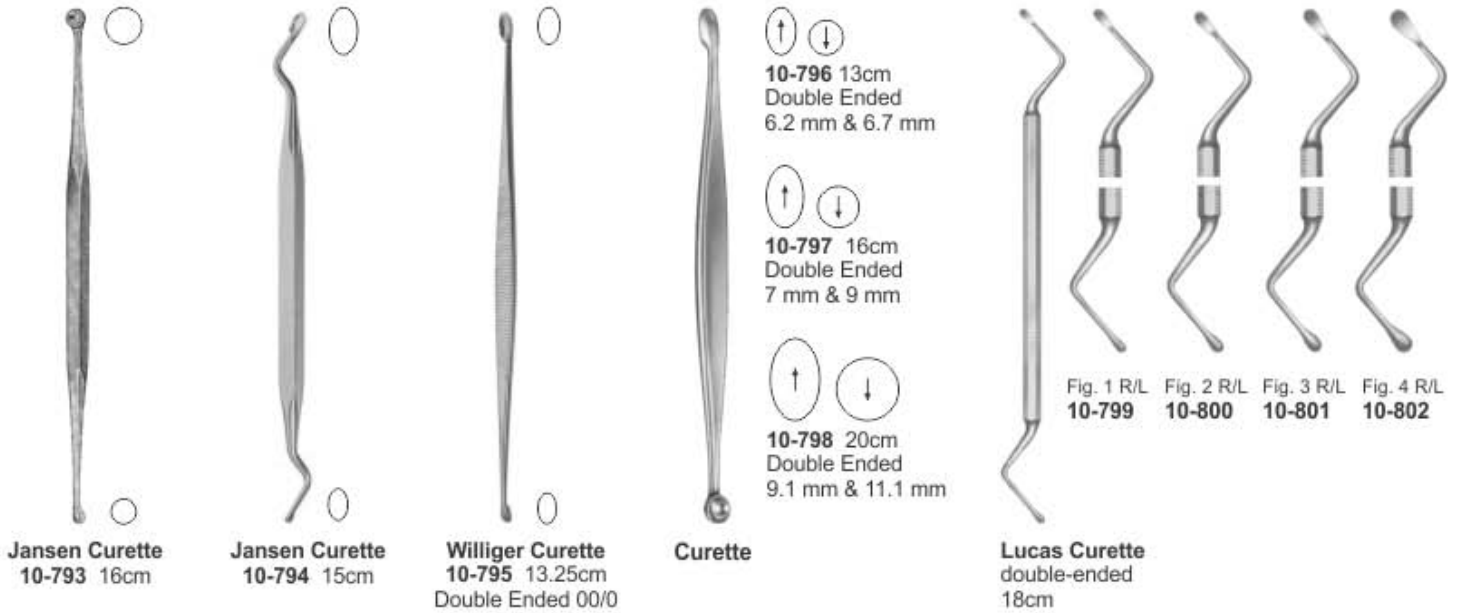

PERIOSTEAL ELEVATORS

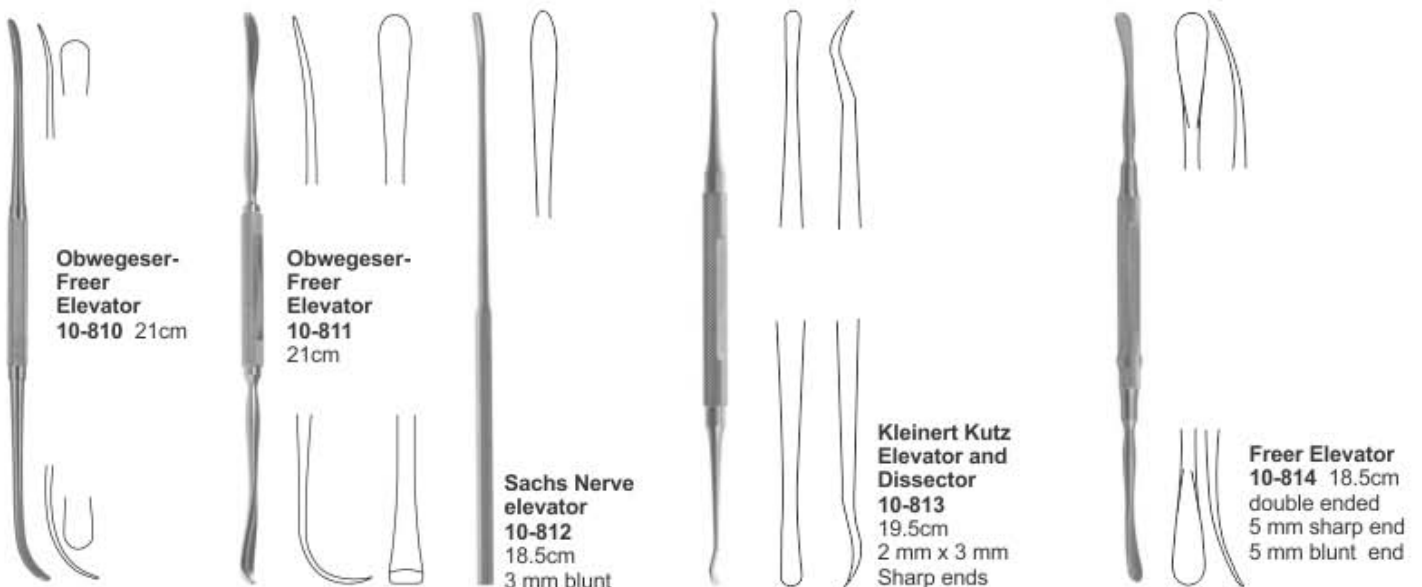
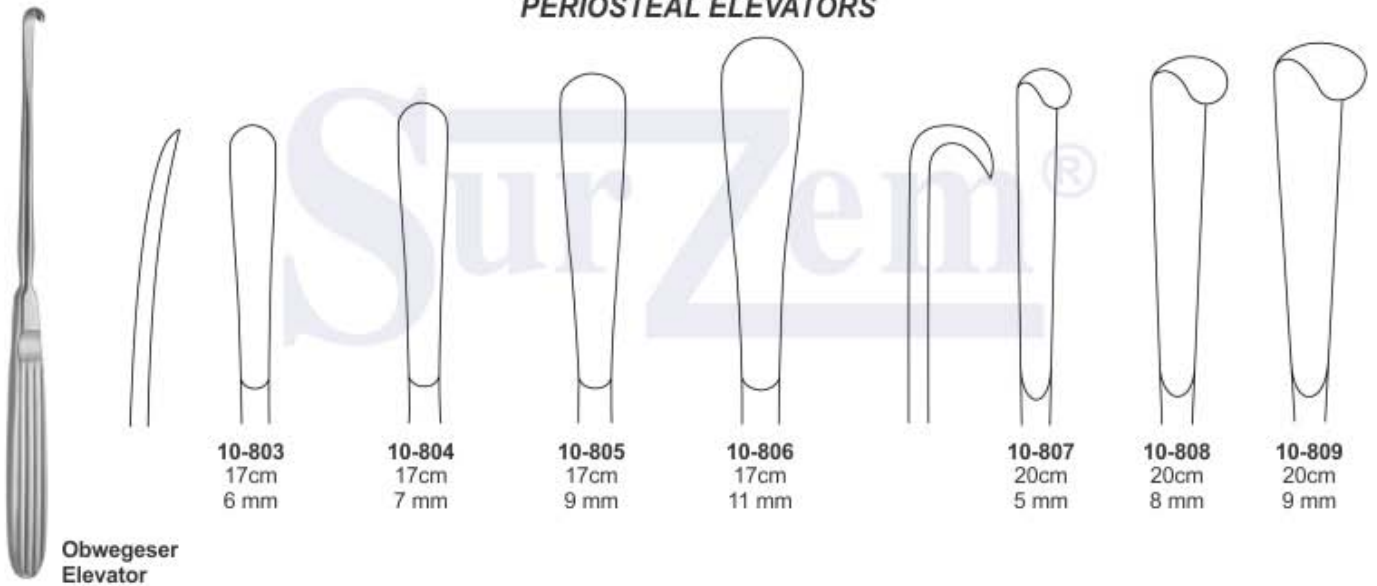

Raspatorien

Rugines-raspatoires

Periostótomos

Periostotomi

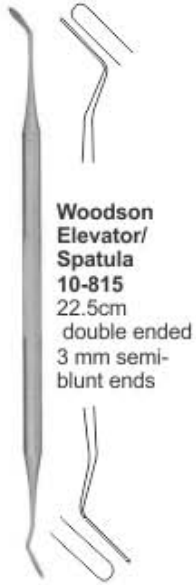

Woodson Elevator/ Spatula 10-815
22.5cm
double ended
3 mm semi-blunt ends

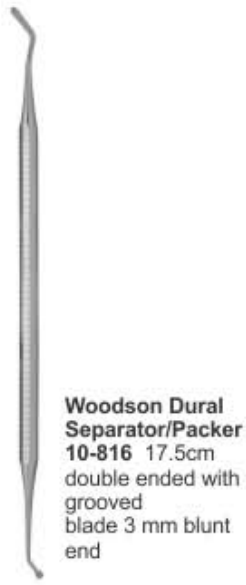

Woodson Dural Separator/Packer 10-816 17.5cm
double ended with grooved blade 3 mm blunt end

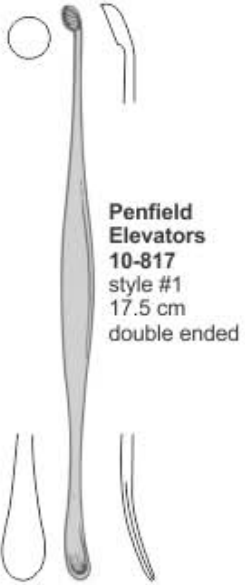

Penfield Elevators 10-817
style #1
17.5 cm
double ended

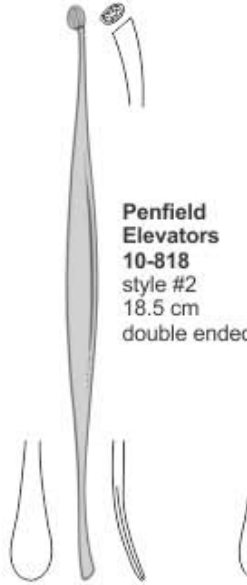

Penfield Elevators 10-818
style #2
18.5 cm
double ended

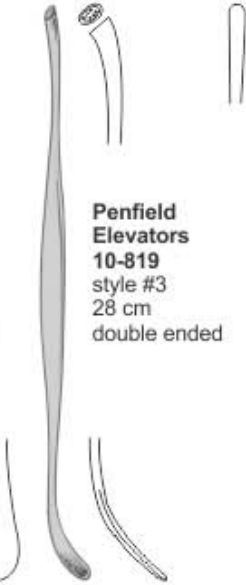

Penfield Elevators 10-819
style #3
28 cm
double ended



Penfield Elevators 10-820
style #4
28 cm
single ended

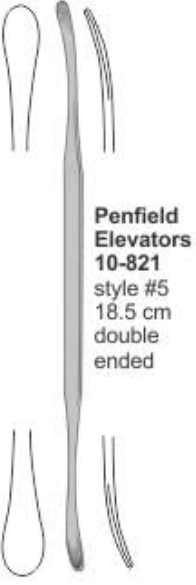

Penfield Elevators 10-821
style #5
18.5 cm
double ended



Alderdyce Elevators 10-822
21.5 cm
double ended



Mc Donald Elevators 10-823
19 cm
double ended



Watson-Cheyne Elevators 10-824
19 cm
double ended



Obwegeser Needle 10-825
17.5cm

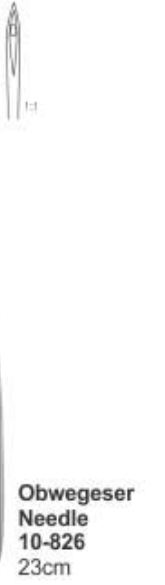

Obwegeser Needle 10-826
23cm



Obwegeser Needle 10-827
18cm



Obwegeser Needle 10-828
14cm



10-829
Right Crved
For Adults

10-830
Right Crved
For Children

Doyen Rib Raspatory
17cm



10-831
Left Crved
For Adults

10-832
Left Crved
For Children

Doyen Rib Raspatory
17cm



Sedillot Elevator 10-833
18.5cm
10-834
21cm

| | |
|---------------|---------------------|
| Raspatorien | Rugines-raspatoires |
| Periostótomos | Periostotomi |



Crego Periosteal Elevator 10-835
15.5cm



Williger Elevator 10-836
13cm
5mm



Williger Elevator 10-837 4mm
10-838 6mm
16cm



Williger Elevator 10-839
16cm
5mm



Williger Elevator 10-840
16cm
6.5mm



Farabeuf-Collin Elevator 10-841
16cm
11mm
Straight



Farabeuf-Collin Elevator 10-842
16cm
11mm
Curved



Farabeuf Elevator 10-843
15cm
Straight



Farabeuf Elevator 10-844
15cm
Curved



Lambotte Elevator 10-845 5mm
10-846 10mm
10-847 15mm
10-848 20mm
10-849 25mm
21cm Straight



Lambotte Elevator 10-850 5mm
10-851 10mm
10-852 15mm
10-853 20mm
10-854 25mm
21cm Curved



Adson Elevator

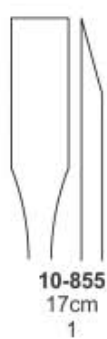

10-855
17cm
1



10-856
17cm
2

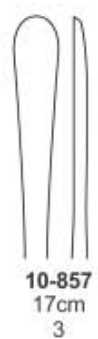

10-857
17cm
3



10-858
17cm
4



Quervain Elevator 10-859 06mm
19.5cm



Trelat Elevator 10-860 8mm
15cm

PERIOSTEAL ELEVATORS

Raspatorien | Rugines-raspatoires
 Periostótomos | Periostotomi

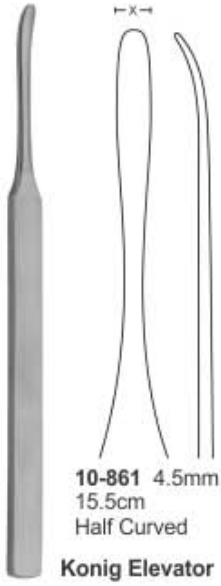

10-861 4.5mm
15.5cm
Half Curved
Konig Elevator



10-862 4.5mm
15.5cm
Full Curved

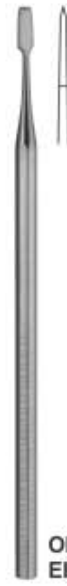

10-863
15cm
2.5mm

10-864
15cm
2.5mm

Obwegeser Elevator



Obwegeser Elevator
10-865
18.5cm



Obwegeser - Freer Osteotome Elevator
10-866
18.5cm



Howarth Periosteal Elevator
10-867
21.5cm
Sharp / Blunt



Langen-Beck Periosteal Elevator
10-868
18cm



Langen-Beck Periosteal Elevator
10-869 19cm



Alexander Periosteal Elevator
10-870 20cm



6 mm
10-871



8 mm
10-872

Periosteal Elevator
17 cm



Semb Periosteal Elevator



10-873
17.5cm
12mm



10-874
21cm
12mm



10-875
17.5cm
12mm



10-876
21cm
13mm



10-877
22.5cm
13mm



10-878
22.5cm
15mm

Raspatorien | Rugines-raspatoires
 Periostótomos | Periostotomi

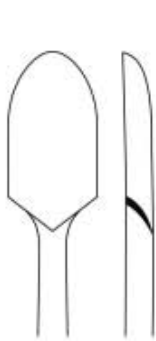

10-879
14mm
Straight
1

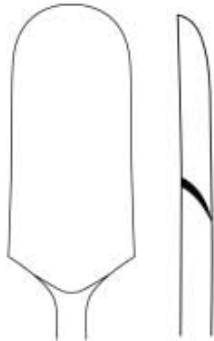

10-880
20mm
Straight
3

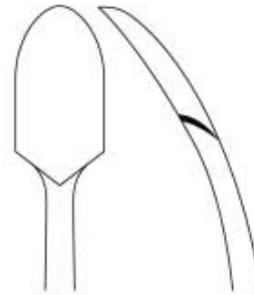

10-881
14mm
Curved
2

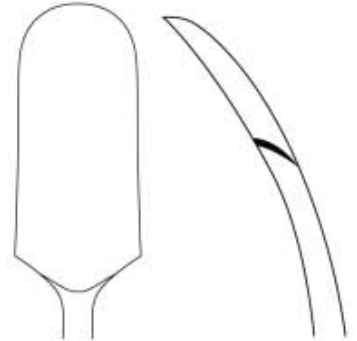

10-882
20mm
Curved
3

Ferozell Periosteal Elevator
20cm



10-883
6mm
1



10-884
3mm
2



10-885
6mm
3

Ferozell Periosteal Elevator
18cm



Periosteal Raspatories
10-886
18.5cm
cvd



Periosteal Elevator
10-887 18cm
Fiber/Phenolic Handle
blade 6mm



Hoen Periosteal Elevator
10-888
16.5cm



Chandler Bone Elevator
10-889 19cm
13 mm
10-890 20cm
20 mm
10-891 23cm
25 mm
10-892 25cm
31 mm



Key Periosteal Elevator 19cm
10-893
6 mm
10-894
12 mm
10-895
20 mm
10-896
25 mm
sharp,
slightly
curved



Pennybacker Periosteal Elevator
10-897
6 mm
17 cm sharp,
curved



Langenbeck Periosteal Elevator
10-898
15 mm
19 cm
sharp, slightly
curved



Cushing Periosteal Elevator 15 mm
10-899
Round Edge
10-900
Square Edge
18 cm

Raspatorien
Periostótomos

Rugines-raspatoires
Periostotomi



Hoen Periosteal Elevator
10-901 7mm, 16cm
10-902 15mm, 19cm
10-903 20mm, 19cm
Semisharp



Sayre Periosteal Elevator
10-904 17cm
one straight blunt
and one curved
sharp



Langenbeck Periosteal Elevator
10-905 7mm
10-906 10mm
20 cm Blunt

7 mm
10 mm



Cushing Periosteal Elevator
19cm
10-907
Left
10-908
Right



Cobb Periosteal Elevator
10-909 10mm
10-910 13mm
10-911 19mm
29cm
Spinal Raspatory

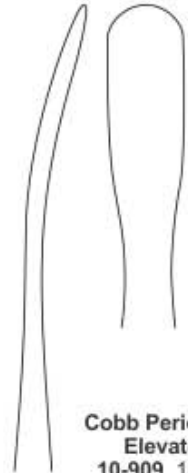

10-912
18cm
8mm



10-915
20cm
19mm

Key Periosteal Elevator



10-913
19cm
10mm



10-916
21cm
25mm



10-914
19cm
12mm



Cobb Periosteal Elevator
10-917 23.4cm
Hex Handle



Darrach Elevator
10-918 26cm
19mm
10-919 35cm
25.4mm
Blunt, Slightly
Curved



Carroll Periosteal Elevator
10-920 14cm
sharp, double ended
3 mm round end,
10 mm flat end



Langenbeck Periosteal Elevator
19.5cm
10-921
blunt edge
10-922
sharp edge



Key Periosteal Elevator sharp edge
10-923 17.7 cm 6.5 mm width
10-924 18.5 cm 9.5 mm width
10-925 18.5 cm 12.7 mm width
10-926 20.0 cm 19.0 mm width
10-927 20.9 cm 25.0 mm width



Lane Bone Elevator
10-928
16cm
Serrated



Lane Bone Elevator
10-929
27cm



Trethowan's Bone Elevator
10-930
22cm



Bristow's Bone Lever
10-931
24cm

Raspatorien, Meniskotome

Rugines-raspatoires, Bisturies para meniscos

Periostótomos, Bistouries a menisques

Periostotomi, Bisturi per menisco



**St. Thomas
10-932**
16cm
Pointed



**St. Thomas
10-933**
16cm
Rounded



**Robinson's
10-934**
17cm



**Freer D
Septum
Knife
10-935**
15cm



**Bircher
Meniscotomy
Knife
10-936**
19cm



**Matson
Meniscotomy
Knife
10-937**
22cm



**Downing
Cartilage
Knife
10-938**
25.5cm
Curved tip,
Straight shaft



**Smillie
Meniscotomy
Knife
10-939** 16cm
Straight Shaft
Blade tip width
is 7.8mm
Straight tip



**Smillie
Meniscotomy
Knife
10-940** 16cm
Curved Shaft
Blade tip width
is 7.8mm
Curved left tip



**Kanadisches
Modell
Meniscotomy
knife
10-941**
20cm



**Kanadisches
Modell
Meniscotomy
knife
10-942**
20cm

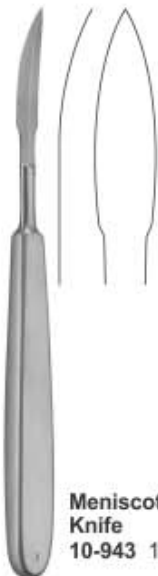

**Meniscotomy
Knife
10-943** 18cm



**Neff Meniscotomy
Knife**



10-944
22cm
left

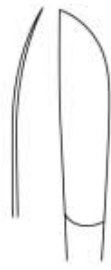

10-945
22cm
right



10-946
4mm

10-947
4.5mm

10-948
5.5mm

**Bunnell Tendon
Strippers**
23cm
Malleable shaft



10-949
Fig. 1
3mm

10-951
Fig. 3
5mm

**Bunnell
Tendon
Strippers**
15.2cm

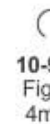

10-950
Fig. 2
4mm

10-952
Fig. 4
6mm

10-953
Fig. 5
7mm



**Fischer
Tendon
Strippers**
10-954
31cm

Sehnenstripper, Knochenhebel

enucleadores de tendones, Elevadores para huesos

Instruments a ecorcher les tendons, Leviers a os

Scollatendini, Elevatori per ossa



Bunnell Tendon Strippers
10-955 23cm
Tendon passer



Kleinert-Kutz Tendon Retriever
10-956
20cm
Serrated



Kleinert-Kutz Tendon Retriever
10-957
20cm
Serrated, flexible shaft



Brand Tendon Tunelling Forceps
10-958 15cm
10-959 19cm
10-960 24cm
Straight, serrated
2 x 3 teeth



Hohmann Bone Elevator
10-961 43mm
24.5 cm



Hohmann Bone Elevator
10-962 22mm
26cm



Hohmann Bone Elevator
10-963 33mm
28cm



Hohmann Bone Elevator
10-964 24mm
26.5cm



Hohmann Bone Elevator
10-965 22mm
26cm



Capsule Retractor
10-966 25.5cm
3 sharp-pronged,
22mm width blade



Bristow-Bankart Humeral Retractor
10-967 19cm
Double-pronged,
25mm width x 102mm
depth blade



Bristow-Bankart Soft Tissue Retractor
10-968 20cm
3-pronged
21mm width blade,



Humeral Head Retractor
10-969 22cm
18mm width blade



Hohmann Bone Elevator
10-970 22cm
08mm width blade
10-971 23cm
10mm width blade

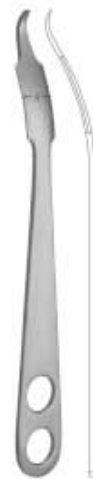

Hohmann Bone Elevator
10-972 24cm
18mm



Hohmann Bone Elevator
10-973 24cm 70mm
10-974 28.5cm 35mm width blade
10-975 33cm 40mm width blade

Knochenhebel | Elevadores para huesos

Leviers a os | Elevatori per ossa



Hohmann Long Shank Retractor 10-976 23cm
43mm width blade



10-977 16cm
6mm width blade

Mini-Hohmann Bone Elevator



10-978 16cm
8mm width blade



Hohmann Bone Lever 10-979 15cm



Hohmann Bone Lever 10-980 15.4cm
Short tip



Hohmann Retractor 10-981 15cm
15mm width blade



Hayes Hand Retractor 10-982 16cm
3mm width blade



Hayes Hand Retractor 10-983 15cm
6mm width blade



10-984 14cm
2.8mm

Bone Lever



10-985 14cm
4.5mm

10-986 14cm
6mm



Bristow Bone Lever 10-987 23cm



Lane Bone Lever 10-988 21cm



Periosteal Elevator 17.5cm
For Metacarpals Small
10-989 6 mm width
For Metacarpals Medium
10-990 10 mm width
Light Curve, Rounded End,
10-991 5 mm width
Contra Angled Curve
10-992 4.5 mm width



Hohmann Retractor 10-993 18cm
Small, width 6 mm
short, narrow tip



Hohmann Retractor 10-994 18cm
Small, width 8 mm
short, narrow tip



Hohmann Retractor 10-995 12.5cm
Finger Ring handle,
16mm width blade



Hohmann-Williger Retractor
10-996
 16cm



Blount Retractor
10-997
 17.5cm



Taylor Retractor
 16.5cm
10-998
 a=75mm - b=30mm
10-999
 a=100mm - b=30mm

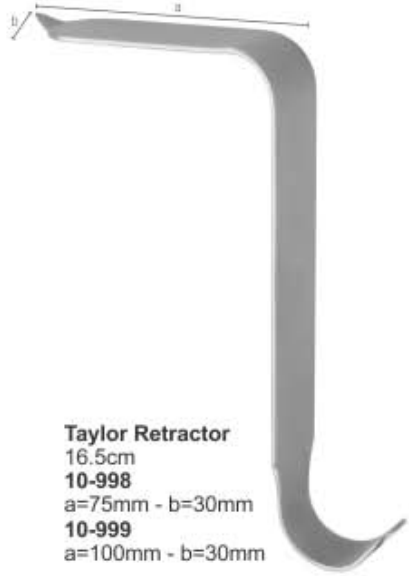

Cushing Vein Retractor
10-1000 22.5cm
 with fenestrated handle
 Blade 12 mm width x 10 mm



Cushing Decompression Retractor
10-1001 21.5cm
 with fenestrated blade and handle
 Blade 13 mm width x 22 mm



Scoville Nerve Retractor
10-1002
 24cm
 7 mm straight



Scoville Nerve Retractor
10-1003
 24 cm, 7 mm angled



Taylor Retractor
 17cm
10-1004 30 x 75 mm
10-1005 30 x 100 mm



Hibbs Retractor
10-1006
 25 x 75 mm, 23cm
10-1007
 25 x 80 mm, 24cm

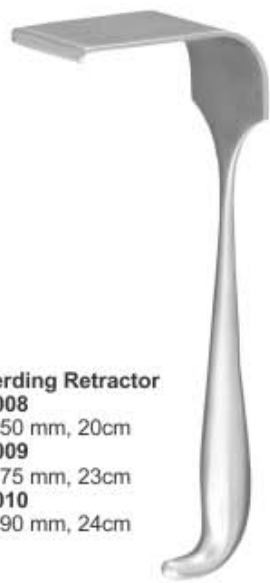

Meyerding Retractor
10-1008
 16 X 50 mm, 20cm
10-1009
 25 X 75 mm, 23cm
10-1010
 50 X 90 mm, 24cm



Nail Extracting Forceps
10-1011
 14cm



Nail Extracting Forceps
10-1012
 14.5cm

Orthopädie, Sehnenstripper

Orthopédie, enucleadores de tendones

Ortopedia, Instruments a ecorcher les tendons

Ortopedia, Scollatendini

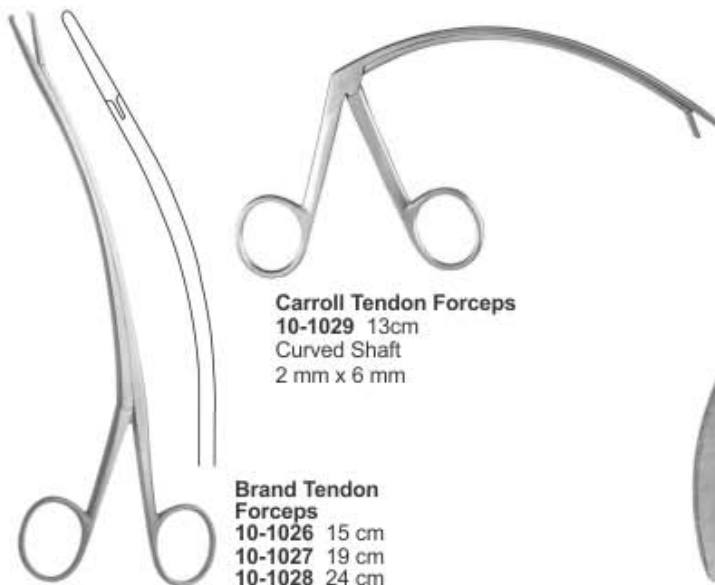
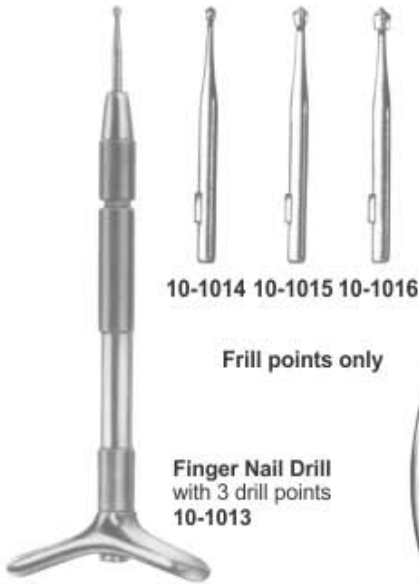

Sehnenstripper, Technische Zangen

enucleadores de tendones, Pinzas técnicas

Instruments a ecorcher les tendons, Pinces techniques

Scollatendini, Pinze tecniche



Flat Nose Pliers
10-1033
13.5cm
Broad, 4mm tip,



Flat Nose Pliers
10-1034 16.5cm
Combination plier and
cutter



Needle Nose Pliers
10-1035 13.5cm



Flat Nose Pliers
10-1036
15cm Delicate,
1.5mm tip



K-Wire Extraction Pliers
W/Screw Lock
10-1037
13cm, 3mm tip



Flat Nose
K-Wire Pliers
10-1038
14cm
10-1039
17cm



Nose Pliers
10-1040
17cm



Utility Technical
Forceps Pliers
10-1041 19cm
adjustable



Wire Bending
Forceps
10-1042 18.5cm



Flat Nose Plier
10-1043 18.5cm
parallel grip, incorporated
cutter, for hard wires up to
1.6mm

Technische Zangen | Pinzas tecnicas
Pinces techniques | Pinze tecniche



Locking Plier
10-1044 18cm
10-1045 20cm
10-1046 24cm



Plate Bending Plier
10-1047 20cm
for plates up to 2.7mm
10-1048 24cm
for plates up to 4mm



Locking Plier
10-1049 22cm
10-1050 25cm
10-1051 30cm
Locking plier, only
10-1052 30cm
with holding pins
10-1053 46cm
with extraction device



Needle-Nose Locking Pliers
10-1054



Needle-Nose Locking Pliers
10-1055



Needle-Nose Locking Pliers
10-1056



Flat Nosed Plier
10-1057 18cm
parallèll, with lateral
wire cutter



Cast Spreader Model Usa
10-1058 23cm
3 Prong



Nail Extractor
10-1059 16cm
with Longitudinal Groove
(for Intramedullary Gliding Nails)

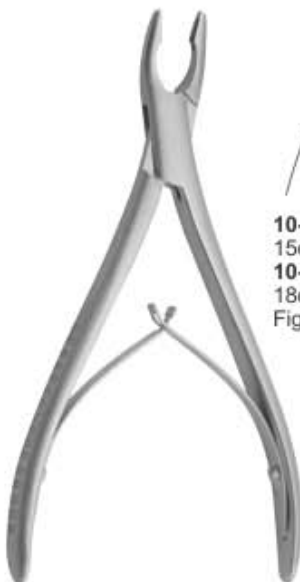

10-1060
15cm
10-1061
18cm
Fig.1



10-1062
15cm
10-1063
18cm
Fig.2

Luer Bone Rongeur
Single action
Curved, 8 x 12mm

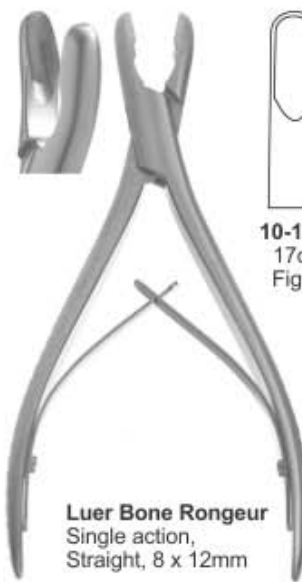

10-1064
17cm
Fig. 1

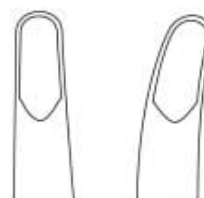

10-1065
17cm
Fig. 2

Luer Bone Rongeur
Single action,
Straight, 8 x 12mm



Friedmann Bone Rongeur
10-1066 14.5cm
Single action, Curved,
4 x 11mm

Hohlmeißelzangen
Pinzas gubias

Pinces-gouges
Pinze-sgorbie

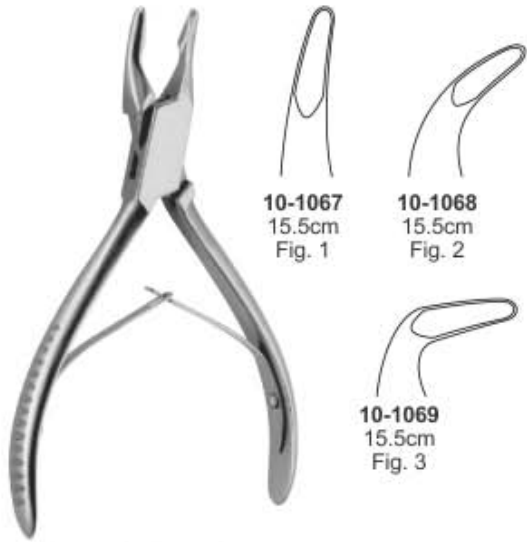

10-1067
15.5cm
Fig. 1

10-1068
15.5cm
Fig. 2

10-1069
15.5cm
Fig. 3

Blumenthal Bone Rongeur

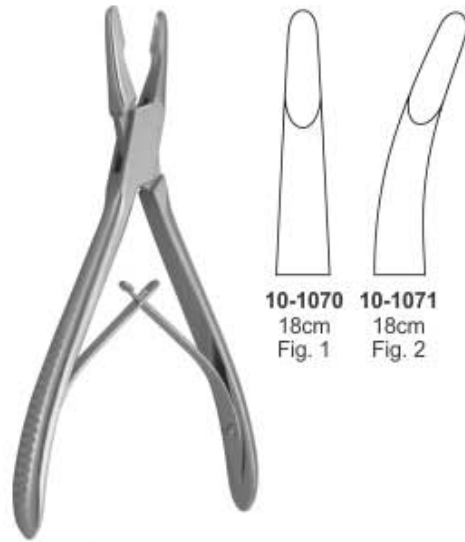

10-1070
18cm
Fig. 1

10-1071
18cm
Fig. 2

Jasen Bone Rongeur

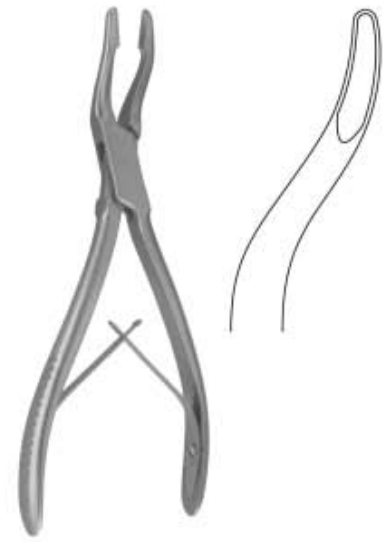

Jansen Bone Rongeur
10-1072 19cm



10-1073
17.5cm
slightly curved

10-1074
17.5cm
Strongly curved

Stellbrink Bone Rongeur

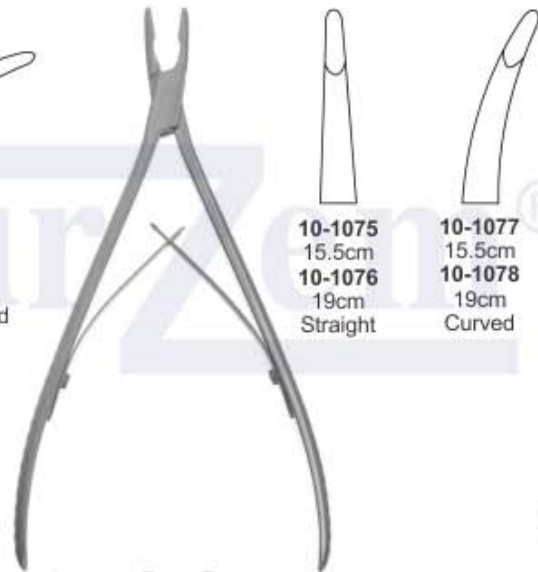

10-1075
15.5cm
10-1076
19cm
Straight

10-1077
15.5cm
10-1078
19cm
Curved

Lempert Bone Rongeur



Rongeur #4
10-1079 14cm
Rongeur #4A
10-1080 16.5cm
Single action,
Curved, 4 x 9mm



Chichirelli (Blumenthal) Rongeur
10-1081 15cm
Single action, Curved 45°,
4 x 13mm



Dean (Blumenthal) Rongeur
10-1082 15cm
Single action,
Curved 90°, 4 x 11mm



Dean Rongeur
10-1083 14.5cm
Single action
Curved, 3mm

Hohlmeißelzangen

Pinces-gouges

Pinzas gubias

Pinze-sgorbie



Hartmann Bone Rongeur
10-1084 18.5cm
Single action
Curved, 4 x 14mm

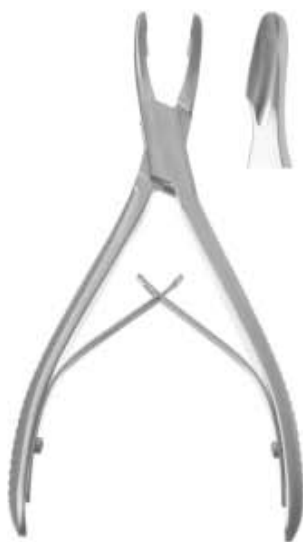

Mead Bone Rongeur
10-1085 16.5cm
Single action,
Curved, 5 x 13mm



Cleveland Bone Rongeur
10-1086 14cm
10-1087 17cm

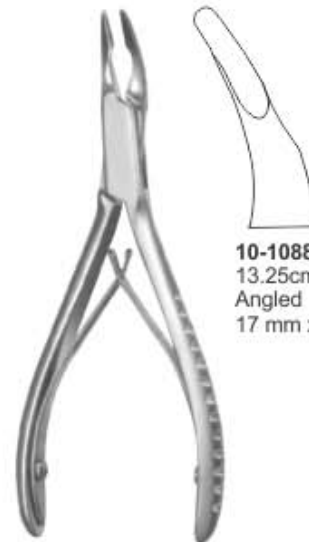

Universal Bone Rongeur

10-1088
13.25cm
Angled
17 mm x 3.5 mm



Bane Bone Rongeur



Bohler Bone Rongeur

10-1089
18cm
Single action
Curved,
3 x 16mm

10-1090
15c
Straight

10-1091
15cm
Curved



Zaufal-Jansen Bone Rongeur
10-1092 18cm
Double action
Curved, 5x15mm



Marquardt Bone Rongeur
10-1093 18cm



Beyer Bone Rongeur
18cm
10-1094 3 x 14mm
10-1095 4 x 15mm
Double action, Curved



Smith-Peterson Laminectomy Rongeur
10-1096 24cm
Double action,
Straight 3 x 16mm



Smith-Peterson Laminectomy Rongeur
10-1097 24cm
Double action
Curved 3 x 16mm

Hohlmeißelzangen
Pinzas gubias

Pinces-gouges
Pinze-sgorbie



Ruskin Rongeur
10-1098 18cm 4x16mm
10-1099 18.5cm 5x10mm
Double action, Curved on side



Ruskin Rongeur
10-1100 18.5cm
Double action, 6 x 16mm,
Straight, Curved



Ruskin Rongeur
10-1101 15.5cm Straight, 3.2mm
10-1102 15cm Curved, 2 x 15mm
10-1103 15cm Curved, 3 x 15mm
Double action,



Riskin Bone Rongeur



10-1104 15.5cm
10-1105 18cm
Double action
Straight, 2 x 14mm



10-1106 15.5cm
10-1107 18cm
Double action
Curved 2 x 14mm



Mayfield Bone Rongeur
10-1108 18cm



Stille-Ruskin Bone Rongeur



10-1109
23cm
Curved



10-1110
23cm
Straight



Leksell Bone Rongeur
10-1111 24.5cm 5 x 13mm
10-1112 24cm 8 x 14.5mm
Double action, Curved 50°



Leksell Rongeur
10-1113 24cm
6 x 15mm
10-1114 24cm
7 x 13mm
Double action, Curved



Leksell Rongeur
10-1115 24cm
3 x 18mm
Double action, Curved



Leksell Rongeur
10-1116 23cm
4 x 13mm
Double action
Fully curved



Stille Bone Rongeur



10-1117
23cm
4mm



10-1118
23cm
6mm



10-1119
23cm
8mm



Stille-Luer Rongeur Forceps



10-1120
23cm
10-1121
27cm
straight



10-1122
23cm
10-1123
27cm
curved



Echlin Duckbill Bone Rongeur 23cm

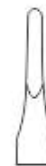

10-1124
2 x 12mm
Double action
Curved on side



10-1125
3 x 12mm
Double action
Curved on side



10-1126
4.5 x 11mm
Double action
Curved on side

Hohlmeißelzangen
Pinzas gubias

Pinces-gouges
Pinze-sgorbie



Stille-Leur Rongeur
10-1127 21.5cm
Curved, Straight
Double action, 10 x 18mm



Stille-Leur Rongeur
10-1128 26.5cm
Straight, Curved
Double action, 10 x 18mm



**Stille-Luer Echlin
Duckbill Rongeur**
23cm
10-1129 6 x 13mm
10-1130 6 x 15mm
Double action Curved on side



Stille-Leur Rongeur
10-1131 21.5cm
Double action
Curved 10 x 16mm



**Rottgen-Ruskin
Bone Rongeur**
10-1132 23cm



Semb Bone Rongeur
10-1133 24cm



Frykholm Bone Rongeur
10-1134 24cm

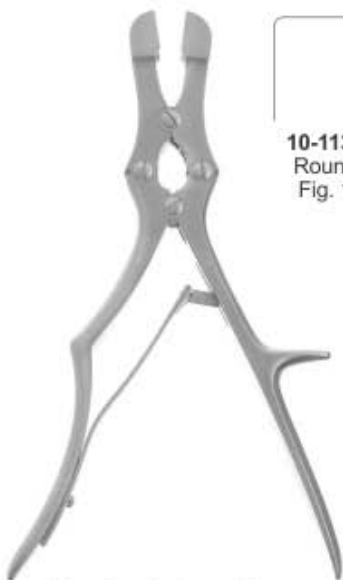

Sauerbruch Bone Rongeur
30cm



10-1135
Round
Fig. 1

10-1136
Straight
Fig. 2



Luer-Stille Bone Rongeur
27cm

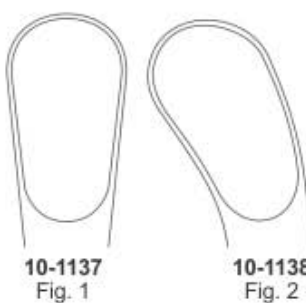

10-1137
Fig. 1

10-1138
Fig. 2



Leksell-Stille Bone Rongeur



10-1139
24cm

10-1140
24cm

Hohlmeißelzangen
Pinzas gubias

Pinces-gouges
Pinze-sgorbie



- 10-1141 25cm 3 x 16mm
- 10-1142 23cm 5 x 16mm
- 10-1143 25cm 4.5 x 16mm
- 10-1144 25cm 6 x 16mm
- 10-1145 25cm 7 x 16mm
- 10-1146 25cm 8 x 16mm
- Double action, Curved 15°

Leksell Bonerongeur



Hakansson Bone Rongeur
10-1147 20cm



Kleinert-Kutz Bone Rongeur



10-1148
15.25cm
2 x 13 mm



10-1149
15.25cm
Curved
18 x 5 mm

Ruskin-Mini Bone Rongeur



- Syfert Rongeur**
- 10-1150 35.5cm 4 x 16mm
 - 10-1151 35.5cm 8 x 16mm
 - 10-1152 35.5cm 12 x 16mm
 - 10-1153 37cm 5 x 16mm
 - Double action, Angled



Cottle-Kazanjian Bone
Cutting Rongeur Forceps
10-1154 19cm



10-1155
15cm
Straight,

Littauer / Liston Bone
Cutting Rongeur Forceps

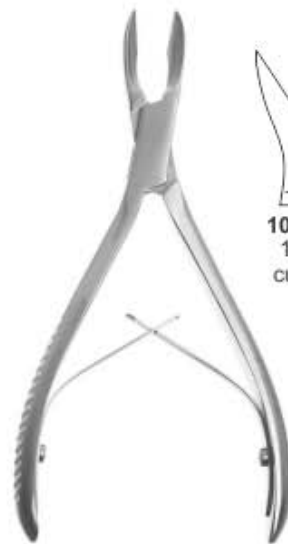

Cleveland Bone Cutting
Rongeur Forceps

10-1156
15cm
curved

10-1157
17cm
curved



Liston Bone Cutting
Rongeur Forceps

10-1158
14cm
Angled

10-1159
17cm
Angled

10-1160
19cm
Angled

10-1161
22cm
Angled

Knochensplitterzangen

Pinzas cortantes para huesos

Pinces coupantes a os

Cesoie per ossa



10-1162 14 cm
10-1163 17 cm
10-1164 19 cm
10-1165 20 cm
10-1166 22 cm
Straight

Liston Bone Cutting Rongeur Forceps



Stille-Liston Bone Cutting Rongeur Forceps



10-1167
27 cm
Straight



10-1168
27cm
Angled 45°



Semb Bone Cutting Rongeur Forceps
10-1170 24cm



10-1169
27 cm
Angled 90°



Liston Key Horsley Bone Cutting Rongeur Forceps
10-1171 27cm



Horsley Bone Cutting Rongeur Forceps 10-1172 25cm



Ruskin Bone Cutting Rongeur Forceps
10-1173 20cm
Double-Action



Cleveland-Gardner Bone Cutting Rongeur Forceps



10-1174
16cm

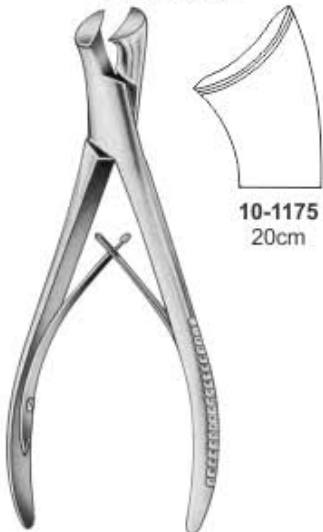

10-1175
20cm

Markwalder Bone Cutting Rongeur Forceps

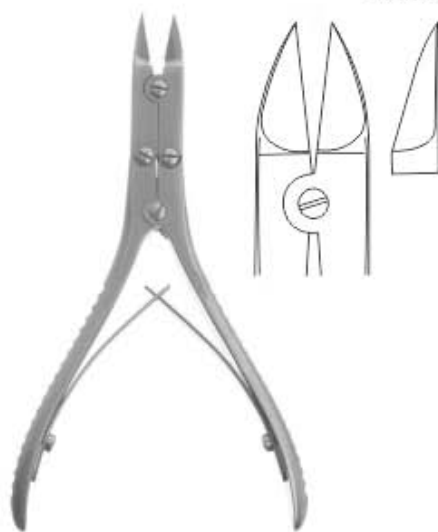

Bone Cutting Rongeur Forceps
10-1176 15cm



10-1177
15cm
Straight



10-1178
15cm
Angled

Bohler Bone Cutting Rongeur Forceps

Knochensplitterzangen
Pinces coupantes a os

Pinzas cortantes para huesos
Cesoie per ossa

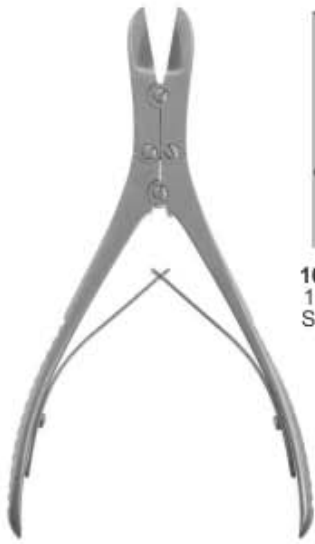

10-1179
18.5cm
Straight



10-1180
18.5cm
Angled



10-1181
15cm
Straight



10-1182
15cm
Angled



10-1183 Straight
10-1184 Curved
10-1185 Angled
19cm deicate

Ruskin-Liston Bone Cutting Rongeur Forceps

Walton-Liston Bone Cutting Rongeur Forceps

Ruskin-Liston Bone Cutting Rongeur Forceps



10-1186
17.5cm
Straight



10-1187
17.5cm
Curved



Mc Indoe Bone Cutting Forceps
10-1188 18cm
Angled, delicate,



Kleinert-Kutz Bone Cutting Forceps
10-1189 15cm
Straight, delicate,



Kleinert-Kutz Synovectomy Rongeur
10-1190 15cm 2 x 10mm
Double action,
Curved on side, delicate,



10-1191
27cm
Straight



Stille-Horsley Bone Cutting Forceps
10-1192 24cm



10-1193
23cm
Angled



10-1194
27cm
Angled

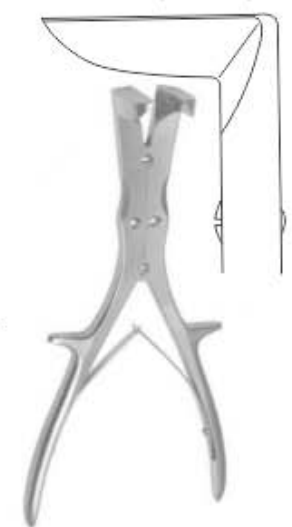

Liston-Stille Bone Cutting Rongeur Forceps
10-1195 26cm

Stille-Liston Bone Cutting Rongeur Forceps

Liston Bone Cutting Rongeur Forceps

Drahtschneidezangen
Pinces coupantes

Alicates para cortar alambre
Pinze taglia Filo

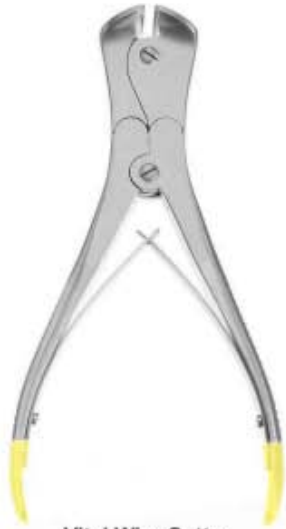

Vital Wire Cutter
10-1196 22cm
for hard wires up to 2.2mm,
for soft wires up to 3mm



Vital Wire Cutter
10-1197 22cm
for hard wires up to 2.2mm,
for soft wires up to 2.8mm



Vital Wire Cutter
10-1198 23cm
for hard wires up to 2.2mm,
for soft wires up to 3mm



Vital Wire Cutter
10-1199 18cm
for hard wires up to 1.5mm,
for soft wires up to 2mm



**Pin Puller W/
Groove TC**
10-1200 14cm



Vital Wire Cutter
10-1201 18cm
for hard wires up to 1.7mm,
for soft wires up to 2mm



Vital Wire Cutter
10-1202 15cm
for hard wires up to 1mm,
for soft wires up to 1.5mm



Vital Wire Cutter
10-1203 14.5cm
for hard wires up to 1mm,
for soft wires up to 1mm



**Cannulated Wire
/ Pin Cutter**
10-1204 19cm
Cuts wire upto 1.6 mm



Hard Wire Cutter Cuts
10-1205 26cm
for hard wires up to 3mm



**Kirschner Wires &
Steinmann
Pins Cutter**
10-1206 57cm
up to 6mm



Side Pin Cutter
10-1207
57.5cm
Side cutting w/
carbide inserts
max. cap: 5/32"



**Vital Heavy
Duty Pliers TC**
10-1208
22cm
Grip Forceps,
Combined
with cutter



**Vital Wire
Extraction
Pliers T.C**
10-1209 5mm
10-1210 7mm
18cm



Side Cutter
10-1211 18.5cm
Welded carbide jaws
max capacity. 1.6mm



Delicate Wire Cutter
10-1212 12.5cm
Side cutting w/ carbide inserts
max capacity. 0.7mm



Front & Side Wire Cutter
10-1213 17cm
Front and side cutting w/ carbide inserts,
double action. Max capacity. 1.6mm



Double Action Wire Cutter
Angled, Side cutting w/
carbide inserts
10-1214 17cm
max cap 1.6mm
10-1215 21.5cm
max cap. 2.4mm



Flush Wire Cutter
10-1216 17cm
Front and side cutting w/ carbide inserts,
double action. Max capacity. 1.5mm



Wire Forceps
10-1217 17cm
Straight, serrated 5.4 mm tip



Pin Cutter Small
10-1218 26cm
Max cap: 3.2mm



Pin Cutter Medium
10-1219 36.5cm
Max cap: 4.7mm



Large Pin Cutter
10-1220 57.5cm
Large, Straight, Max.
capacity 6.3mm



Stille Plaster Shear
10-1221 37cm



**Schumacher Sternum
Shears**
10-1222 21cm

BONE HOLDING CLAMPS - BONE HOLDING FORCEPS

Knochenhalteklammern - Knochenhaltezangen | Pinzas porta huesos - Pinzas para huesos

Daviers a os - Daviers porte-so

Tenaglie per ossa



Gerster-Lowmann Bone Clamp
 10-1223 12cm
 10-1224 14.5cm
 10-1225 18cm, 28mm
 10-1226 20cm, 35mm
 10-1227 22cm, 40mm
 1x2 Jaws



Lowmann Bone Clamp
 10-1228 12cm
 10-1229 15cm
 10-1230 17cm
 10-1231 18.5cm
 10-1232 20cm



Lambert-Lowman Bone Clamp
 10-1233 17.5cm
 10-1234 20.3cm
 2x2 Jaws

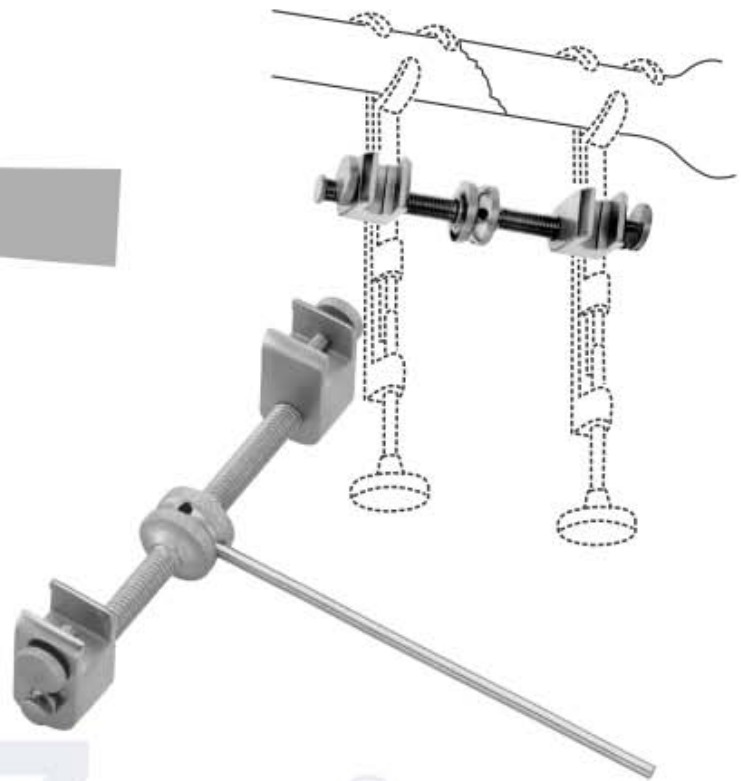

Gerster Bone Holding Clamp
 10-1235 15cm



Gerster Bone Holding Clamp
 10-1236

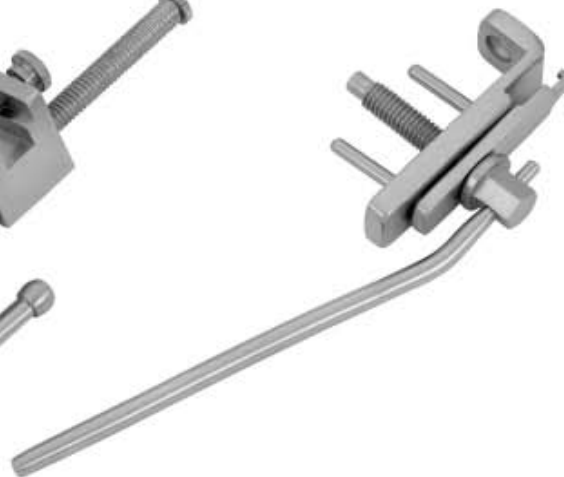

Gerster Bone Holding Clamp
 10-1237



Parham-Martin Bone Clamp
 10-1238 21cm
 Straight



Parham Martin Bands
 10-1239 19cm

Knochenhaltezaugen - Repositionszaugen

Pinzas para huesos - pinzas para reposicion

Daviers porte-so-pinces de reposition

Tenaglie per ossa - Pinze per riposizioni



Bone Reduction Forceps
10-1240 13.5cm



Locke Phalangeal Forceps
10-1241 14cm



Lewin Perforating Bone Holding Forceps

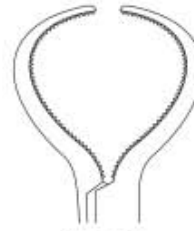

10-1242
17.5cm
serrated



Stagbeetle Bone Reduction Forceps
10-1243 Pointed tips, 13cm



10-1244
13.5cm
Angled
Serrated

Bone Reduction Orthopedic Forceps



Shoulder Percussion Awl
Pointed, 21.6cm
10-1245 Small
10-1246 Medium
10-1247 Large
10-1248 Pointed, 23.5cm



Meniscus Clamp
10-1249 13.5cm
Serrated



Meniscus Clamp
10-1250 13.5cm
Angled 20°, serrated



Preston Logamentum Flavum Forceps
10-1251 19cm
Curved, 1 x 2 teeth



Meniscus Clamp
10-1252 18cm
Straight, Curved shaft



Dingman Bone Clamp
10-1253 19cm
Straight, Serrated,
1 1/2" tip length, Curved shaft

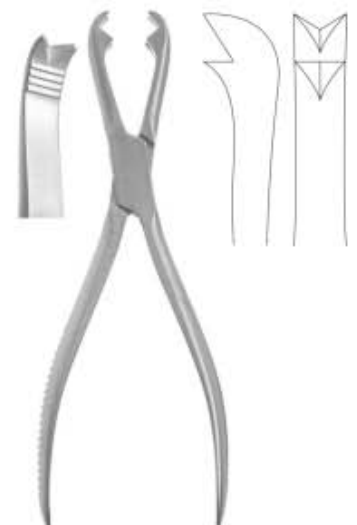

Fergusson Bone Holding Forceps
10-1254 21cm 2 x 2 teeth

Knochenhaltezaugen

Pinzas para huesos

Daviers porte-so

Tenaglie per ossa



10-1255
23cm

Van Buren Sequestrum Forceps
Curved on side, serrated



Langenbeck Bone Holding Forceps
10-1256 21cm



Semb Bone Holding Forceps
10-1257 19cm without ratchet
curved sideways deep teeth



Semb Bone Holding Forceps
10-1258 20.3cm, with ratchet
curved sideways deep teeth



10-1259
17.8cm
10-1260
20cm
10-1261
23cm
straight

Sequestrum (Nircosis) Bone Holding Forceps



10-1262
17.8cm
10-1263
20cm
10-1264
23cm
angled on flat

Farabeuf Bone Holding Forceps with adjustable jaw



10-1265
23cm
10-1266
26cm



10-1267
26cm

Farabeuf-Lambotte Bone Holding Forceps with adjustable jaw

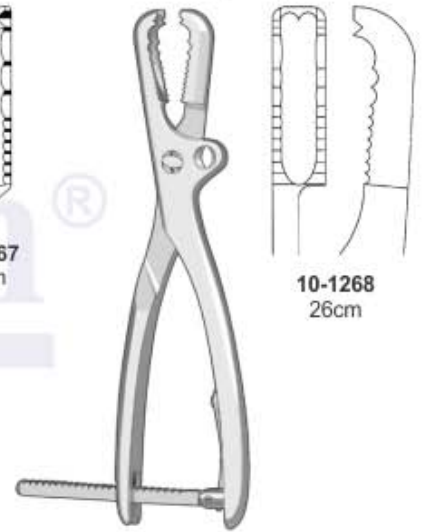

10-1268
26cm

Farabeuf-Lambotte Bone Holding Forceps with adjustable jaw



Bishop Bone Clamp
10-1269 22.5cm
Straight



Kern Bone Holding Forceps
10-1270 17cm
10-1271 24cm
without ratchet



Kern Bone Holding Forceps
10-1272 17cm
10-1273 24cm
with ratchet



10-1274
21cm
10-1275
27cm
10-1276
30cm
Hey Groves Bone Holding Forceps

Knochenhaltezaugen
Daviers porte-os

Pinzas para huesos
Tenaglie per ossa



- 10-1277**
33cm 11 mm tip W/ Ratchet
- 10-1278**
33cm 13 mm tip W/ Ratchet
- 10-1279**
43cm 13.5 mm tip W/ Ratchet
- 10-1280**
13cm 10 mm tip W/o Ratchet

Lane Bone Holding Forceps
Light Model



Lane Bone Holding Forceps
10-1281 33cm 13 mm tip
10-1282 43cm 12 mm tip
without ratchet



Ulrich Bone Holding Self Retaining Forceps



- 10-1283** 18 cm mini
- 10-1284** 22 cm
- 10-1285** 26 cm
- 10-1286** 28 cm
- Straight with speed lock

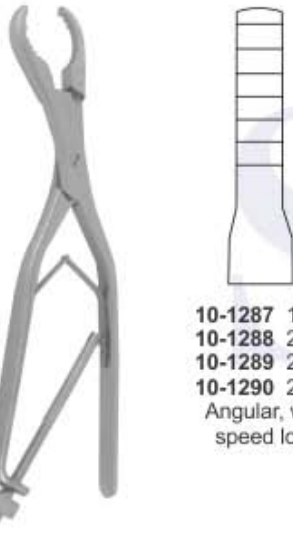

- 10-1287** 18cm
- 10-1288** 22cm
- 10-1289** 26cm
- 10-1290** 28cm
- Angular, with speed lock

Ulrich Bone Holding Forceps



- 10-1291**
28cm

Ulrich Bone Holding Forceps
Angular With Speed Lock & swivel jaw



- 10-1292**
22cm
- 10-1293**
27cm
- 10-1294**
30cm

Lambotte Bone Holding Forceps
One Jaw Mobile adjustable jaw



Lane Bone Holding Forceps
10-1295 31.5cm
10-1296 39cm



- 10-1297**
15 cm, 2.5mm
- 10-1298**
19 cm, 6.5mm
- 10-1299**
24 cm, 9.5mm
- 10-1300**
26 cm, 10mm
- 10-1301**
28 cm, 11mm

Lambotte Bone Holding Forceps
Self-Centering, with speed lock



Subacromion Spreader
10-1302 26.75cm Right
10-1303 26.75cm Left



Bone Reduction Forceps
10-1304 14cm
Serrated with pointed tips

BONE HOLDING FORCEPS

Knochenhaltezaugen

Pinzas para huesos

Daviers porte-os

Tenaglie per ossa



Bone Reduction Forceps
10-1305 14cm Curved
10-1306 15cm Serrated



10-1307
14cm Serrated
10-1308
14cm Curved
10-1309
17cm Curved

**Bone Reduction Forceps,
Pointed Tips**



Semb Bone Holding Forceps
Curved on side
10-1310 19cm 4 x 5 teeth
10-1311 21cm 5 x 5 teeth



**Martin Cartilage Bone Holding
Clamp Forceps**
10-1312 19 cm Str.



10-1313
20cm
Str.

**Bircher-Ganske
Bone Holding Forceps**



10-1314
20cm
Cvd.



10-1315
17.5cm
5.0mm

10-1316
25cm
9.5mm

10-1317
26cm
10.5mm

10-1318
27cm
12.0mm

**Verbrugge Bone
Holding Forceps**

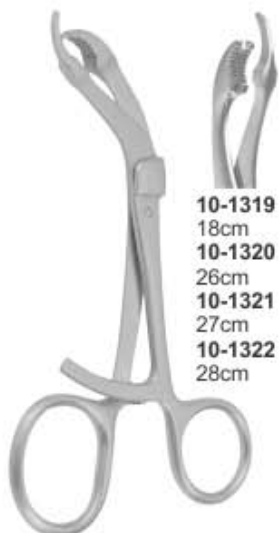

10-1319
18cm
10-1320
26cm
10-1321
27cm
10-1322
28cm

**Verbrugge Bone
Holding Forceps
W/ Long Ratchet**



10-1323
17.2cm

**Verbrugge Bone Holding
Forceps
with short ratchet**



10-1324 15 cm
10-1325 19 cm
10-1326 24 cm
10-1327 26 cm
10-1328 29 cm

**Verbrugge Self-Centering
Bone Holding Forceps
with long ratchet**



**Lane Bone Plate Holding
Forceps**
10-1329 22cm

*Knochenhalte-
zangen*
Daviers porte-so

Pinzas para huesos
Tenaglie per ossa



Verbrugge Bone Holding Forceps
10-1330 18cm



Verbrugge Bone Holding Forceps
10-1331 18cm



10-1332
25cm
10-1333
26cm
10-1334
27cm

Verbrugge Bone Holding Forceps

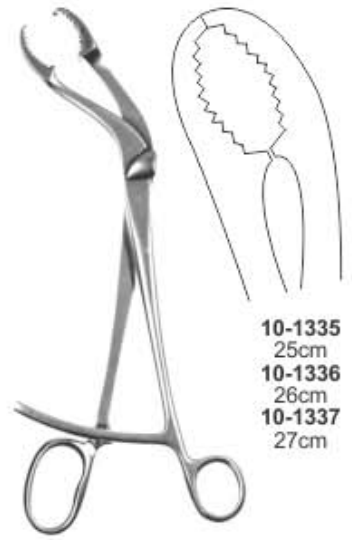

10-1335
25cm
10-1336
26cm
10-1337
27cm

Verbrugge Bone Holding Forceps



Verbrugge Bone Holding Forceps
10-1338 18cm



10-1339
25cm
10-1340
26cm
10-1341
27cm

Verbrugge Bone Holding Forceps



Bone Reduction Forceps
10-1342 13.5cm



Reill Bone Reduction Forceps
10-1343 17cm
Curved, pointed tips



Bone Reduction Forceps
10-1344 20.4cm
Pointed tips



Bone Reduction Forceps
10-1345 13.5cm
for maxillary reposition



Haase
10-1346 16.5cm
for mandibular fractures



Bone Holding forceps

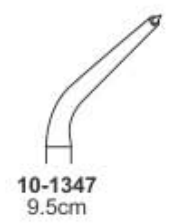

10-1347
9.5cm

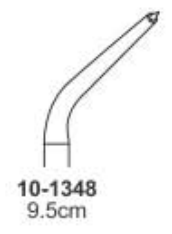

10-1348
9.5cm

Knochenhaltezaugen
Daviers porte-so

Pinzas para huesos
Tenaglie per ossa



Fibula Bone Holding Forceps
10-1349 22cm



Glenoid Perforating Forceps
10-1350 17cm
Lightly curved, pointed tips
Strongly curved, pointed tips



Reil Bone Holding Forceps
10-1351 17cm



Bone Reduction Forceps with Points
10-1352 20cm



Pelvic Reduction Forceps Asymmetric
10-1353 40cm



Malleolar Bone Holding Forceps
10-1354 21cm
Straight, 1 x 1 teeth



Patella Malleolar Forceps
10-1355 21cm



Reduction Forceps with Thread Lock

10-1356 16cm
10-1357 24cm



Reposition Forceps
10-1358 23cm



Pelvic Reposition Forceps
10-1359 19cm
10-1360 23cm



Pelvic Reposition Forceps
10-1361 25cm



Pelvic Reposition Forceps with 3 Balls Spikes
10-1362 25cm



Pelvic Reduction Forceps Asymmetric with 3 ball Spikes
10-1363 25cm



Pelvic Reduction Forceps Asymmetric
10-1364 25cm



Pelvic Reposition Forceps
10-1365 40cm



Pelvic Reposition Forceps
10-1366 40cm

Handbohrapparate
Perforateurs a main

Perforadores de mano
Perforatori a mano



Bunnell Drill
10-1367 16cm
Opening up to 4mm
10-1368 spare key
light metal housing
longitudinally cannulated



Ralk Drill
10-1369 16cm
Opening up to 6.35mm
light metal housing
longitudinally cannulated



10-1372



Plaster Saw Electronic Power
Volt #110
10-1370
Volt #220
10-1371



10-1373
Spare Blade



Moore Drill And Bit Set Complete
10-1374



Fig. 1 10-1376 2.5mm
Fig. 2 10-1377 3.0mm
Fig. 3 10-1378 3.5mm
Fig. 4 10-1379 4.0mm
Fig. 5 10-1380 5.0mm
Fig. 6 10-1381 8.0mm
Fig. 7 10-1382 12.0mm
Fig. 8 10-1383 16.0mm
Fig. 09 10-1384
Fig. 10 10-1385 1.0mm
Fig. 11 10-1386 1.5mm
Fig. 12 10-1387 2.0mm

Stille Pattern Drill Set
10-1375
Complete set of stainless
drill bits and burs

Handbohrapparate

Perforadores de mano

Perforateurs a main

Perforatori a mano



10-1388
Hudson Brace 26.7cm
with standard thumb screw chuck

- C 10-1390 Hudson Bur, 9mm Diameter
- D 10-1391 Hudson Bur, 14mm Diameter
- E 10-1392 Hudson Bur, 16mm Diameter
- F 10-1393 Hudson Bur, 22mm Diameter
- G 10-1394 Cushing Perforator, for Hudson Brace
- H 10-1395 Hudson Cerabellar Extension, 4" for Hudson Brace
- I 10-1396 McKenzie Perforator for Hudson Brace

10-1389
Hudson Brace 27.9cm
with Improved Snap-Lock chuck



Jacobs
10-1397 28cm
opening up to 6.35mm



Hand Drill
10-1398
opening up
to 6.35mm



T-Handle
10-1399
AO Coupling



Jacob's Chuck
10-1400 T-Handle and key
10-1401 only
10-1402 Key



Key Handle
10-1403



T-Handle
10-1404
for AO Coupling



Memoral Head Extractor
10-1405

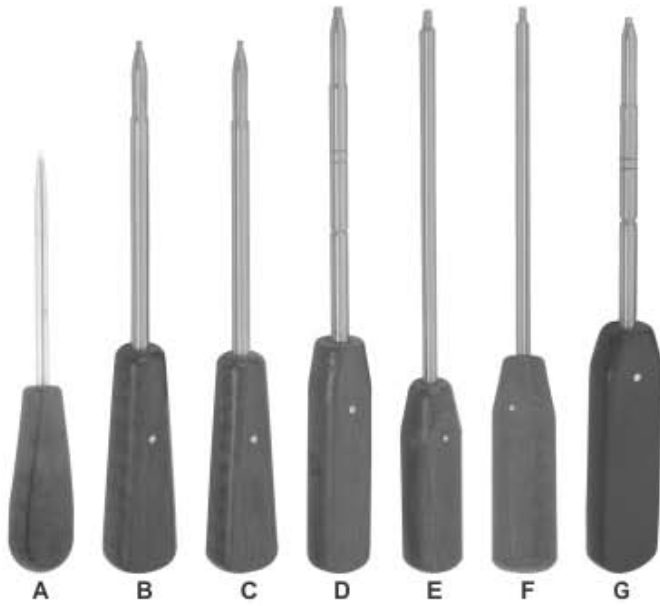

HEXAGONAL HEAD

| | Size of screws | Head Size | Fiber-Handle | AO Coupling | Dental Coupling |
|---|----------------|-----------|--------------|-------------|-----------------|
| A | 1.5mm | 1.5mm | 10-1406 | 10-1409 | 10-1412 |
| B | 2.0mm | | | | |
| C | 2.7mm | 2.5mm | 10-1407 | 10-1410 | |
| D | 3.5mm | | | | |
| E | 4.0mm | | | | |
| F | 4.5mm | 3.5mm | 10-1408 | 10-1411 | |
| G | 6.5mm | | | | |



Parallel Target Device
10-1413
for guide wires 2mm

Mortising Chisel
10-1414

Wire Guide
10-1415
45mm

Wire Guide
10-1416
70mm

Countersink
10-1417

Countersink
10-1418

Countersink
10-1419

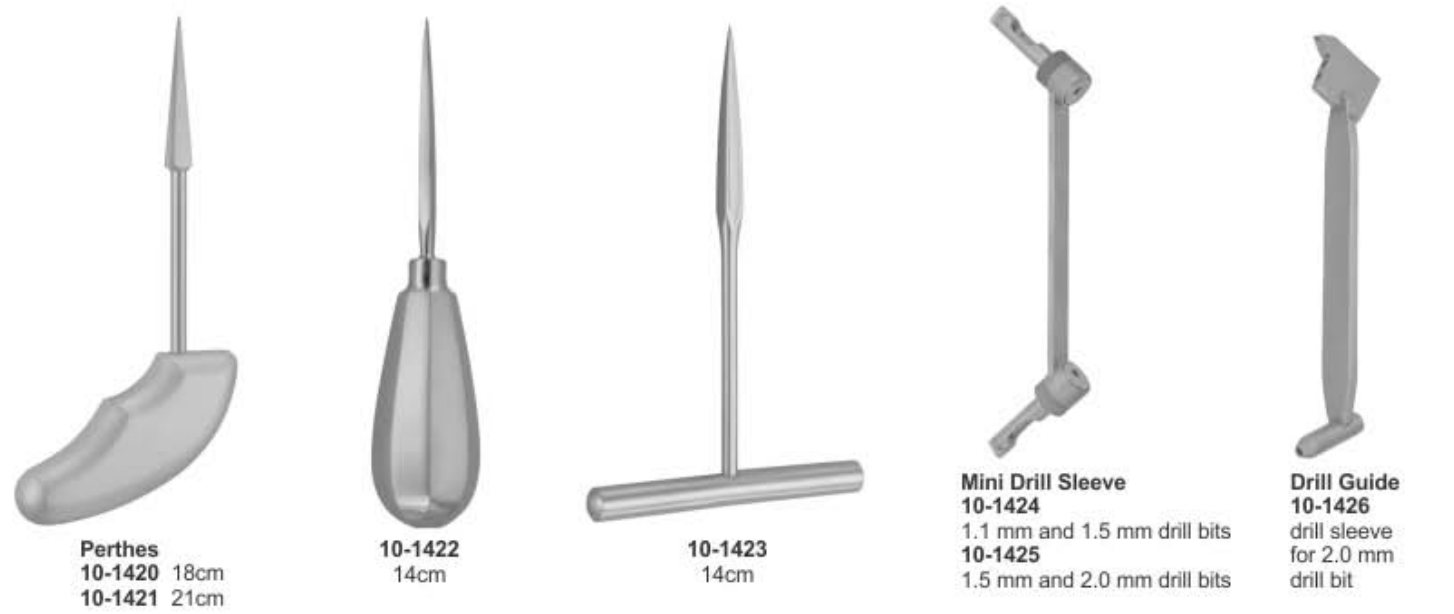

Perthes
10-1420 18cm
10-1421 21cm

10-1422
14cm

10-1423
14cm

Mini Drill Sleeve
10-1424
1.1 mm and 1.5 mm drill bits
10-1425
1.5 mm and 2.0 mm drill bits

Drill Guide
10-1426
drill sleeve for 2.0 mm drill bit



10-1427 Tap Sleeve, 2.0 mm ø
10-1428 Drill Sleeve, 2.7 mm ø
10-1429 Tap Sleeve, 2.5 mm ø
10-1430 Drill Sleeve, 3.5 mm ø



Neutral & Load Drill Guide
10-1431 1.5 mm for 2.0 mm Screws
10-1432 2.0 mm for 2.7 mm Screws
10-1433 2.5 mm for 3.5 mm Screws
10-1434 3.2 mm for 4.5 mm Screws



Tap Sleeve
10-1435
 3.5 mm



Tap Sleeve
10-1436
 3.5 mm also for used
 as 3.2 mm drill Guide



Tap Sleeve
10-1437
 4.5 mm



Drill Sleeve
10-1438 3.2 mm
 for Round Hole Plates



Drill Guide
10-1439 4.5 mm Screws
 Drill Bit 4.5 mm & 3.2 mm



Drill Guide
10-1440 6.5 mm Screws
 Drill Bit 3.2 mm



Drill Guide
10-1441 3.5 mm for neutral and
 compression Positioning Drill Bit 2.5 mm



C - Clamp
10-1442
 Drill Guide with thread
 for Drill Bit 4.5 mm



Insert Drill Sleeve
10-1443 2.7 / 2.0 mm Drill Bit 2.0 mm
10-1444 3.5 / 2.5 mm Drill Bit 2.5 mm
10-1445 4.5 / 3.2 mm Drill Bit 3.2 mm



Drill Small Pointed
10-1446 Drill Bit 3.5 mm



Drill Pointed Guide
10-1447 6.5 mm



Drill Pointed Guide
10-1448 6.5 mm

Plattenbiegevorrichtungen

Dispositivos de doblado de placas

Dispositifs de cintrage de plaques

Dispositivi di piegatura della piastra



**Bending Device
10-1449**
21.5cm
to bend straight
and angled plates



**Bending Device
10-1450**
21.5cm
to bend straight
and angled plates



**Rod Bender
10-1451**
to bend straight
and angled



**Universal Rod Bender
10-1452** 28.5cm
to bend straight
and angled



**Rod Bender
10-1453**
to bend straight
and angled



**Slotted Hammer
10-1454** 14mm



**Plate Bender
10-1455**



**Plate Bender
10-1456**



**Plate Bender
10-1457**



**Plate Bender
10-1458**



**Plate Bender
10-1459**



**Plate Bender
10-1460**



**Plate Bender
10-1461**

*Extensionsbugel
Etriers pour extension*

*Estribos para extension
Archi per estensione*



10-1462 18cm
Wire strainer for
kirschner wires



Kirschner Extension Bows
10-1463 x=95mm y=70mm
10-1464 x=100mm y=100mm
10-1465 x=120mm y=120mm
10-1466 x=155mm y=155mm
10-1467 x=200mm y=155mm
 with 3 traction hooks



Kirschner Extension Bows
10-1468 x=130mm
10-1469 x=185mm
10-1470 x=220mm
 with 3 traction hooks



**Wrench
Kirschner
Extension Bows**
10-1471
 14mm/17mm

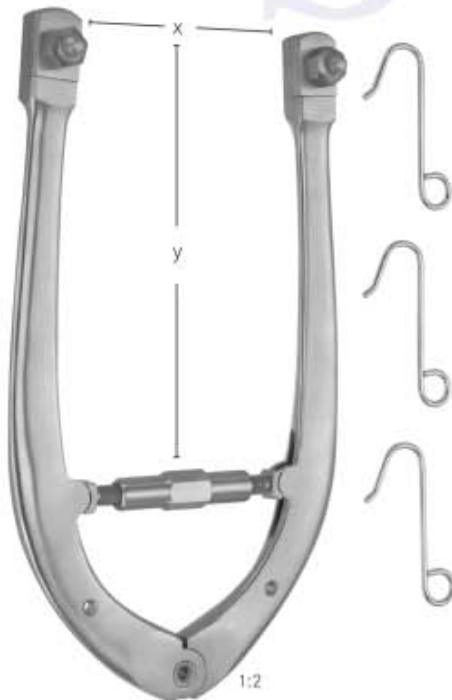

Kirschner Extension Bows
10-1472 x=180mm y=100mm
10-1473 x=270mm y=160mm
 with 3 traction hooks

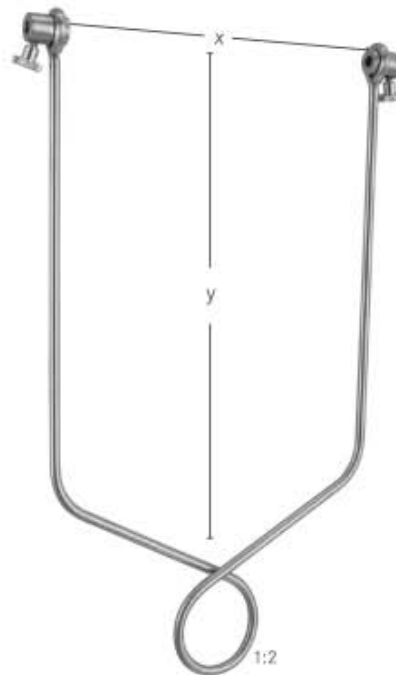

Bohler Kirschner Extension Bows
10-1474 x=75mm y=90mm
10-1475 x=90mm y=160mm
10-1476 x=110mm y=210mm
10-1477 x=150mm y=210mm
 with 3 traction hooks



**Charnley-mueller
10-1478
Compression Clamp**



Screw Depth Gauges

- 10-1479 Mini Gauge, Longmeasures up to 30mm
- 10-1480 Small Gauge, Longmeasures up to 50mm
- 10-1481 Large Gauge, Longmeasures up to 100mm
- 10-1482 X-Large Gauge, Longmeasures up to 120mm



Screw Depth Gauges

- 10-1483 Mini Gauge, Longmeasures up to 30mm
- 10-1484 Small Gauge, Longmeasures up to 50mm
- 10-1485 Large Gauge, Longmeasures up to 100mm
- 10-1486 X-Large Gauge, Longmeasures up to 120mm



**Measuring Gauge
10-1487
for nail**

10-1488 Tri Angular Positioning Plate

